

**Smart Sensor  
ZFX-C20**

# **Vision Sensor with built-in LCD monitor**

# **USERS MANUAL**

**OMRON**

# Introduction

---

Thank you for purchasing the ZFX-C.

This manual provides information regarding functions, performance and operating methods that are required for using the ZFX-C.

When using the ZFX-C, be sure to observe the following:

- The ZFX-C must be operated by personnel knowledgeable in electrical engineering.
- To ensure correct use, please read this manual thoroughly to deepen your understanding of the product.
- Please keep this manual in a safe place so that it can be referred to whenever necessary.

## Manuals Provided with this Product

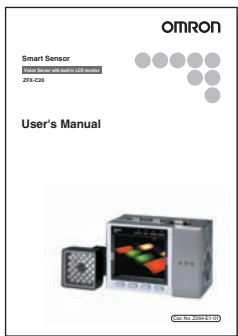

### User's Manual (this document)

This manual describes basic operations, such as installation and connections, and information on settings and specifications to ensure safe and correct use of this product.

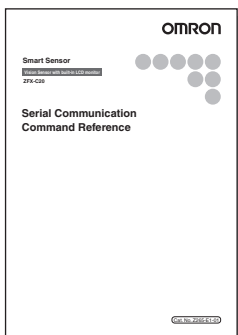

### Serial Communication Command Reference

This manual provides reference information for when this product performs communications with an external device, such as a PC or a programmable controller, via the serial interface.

# User's Manual

APPLICATION CONSIDERATIONS  
(Please Read)

---

BEFORE USE

---

**1**

BASIC OPERATIONS

---

**2**

SETTING THE MEASUREMENT  
CONDITIONS

---

**3**

FUNCTIONS USED DURING OPERA-  
TION

---

**4**

ADDITIONAL FUNCTIONS

---

**5**

PARALLEL INTERFACE

---

**6**

APPENDICES

---

**7**

Smart Sensor

Vision Sensor with built-in LCD monitor  
ZFX-C20

## **READ AND UNDERSTAND THIS DOCUMENT**

Please read and understand this document before using the products. Please consult your OMRON representative if you have any questions or comments.

## **WARRANTY**

OMRON's exclusive warranty is that the products are free from defects in materials and workmanship for a period of one year (or other period if specified) from date of sale by OMRON.

OMRON MAKES NO WARRANTY OR REPRESENTATION, EXPRESS OR IMPLIED, REGARDING NON-INFRINGEMENT, MERCHANTABILITY, OR FITNESS FOR PARTICULAR PURPOSE OF THE PRODUCTS. ANY BUYER OR USER ACKNOWLEDGES THAT THE BUYER OR USER ALONE HAS DETERMINED THAT THE PRODUCTS WILL SUITABLY MEET THE REQUIREMENTS OF THEIR INTENDED USE. OMRON DISCLAIMS ALL OTHER WARRANTIES, EXPRESS OR IMPLIED.

## **LIMITATIONS OF LIABILITY**

OMRON SHALL NOT BE RESPONSIBLE FOR SPECIAL, INDIRECT, OR CONSEQUENTIAL DAMAGES, LOSS OF PROFITS OR COMMERCIAL LOSS IN ANY WAY CONNECTED WITH THE PRODUCTS, WHETHER SUCH CLAIM IS BASED ON CONTRACT, WARRANTY, NEGLIGENCE, OR STRICT LIABILITY.

In no event shall responsibility of OMRON for any act exceed the individual price of the product on which liability is asserted.

IN NO EVENT SHALL OMRON BE RESPONSIBLE FOR WARRANTY, REPAIR, OR OTHER CLAIMS REGARDING THE PRODUCTS UNLESS OMRON'S ANALYSIS CONFIRMS THAT THE PRODUCTS WERE PROPERLY HANDLED, STORED, INSTALLED, AND MAINTAINED AND NOT SUBJECT TO CONTAMINATION, ABUSE, MISUSE, OR INAPPROPRIATE MODIFICATION OR REPAIR.

## **SUITABILITY FOR USE**

THE PRODUCTS CONTAINED IN THIS DOCUMENT ARE NOT SAFETY RATED. THEY ARE NOT DESIGNED OR RATED FOR ENSURING SAFETY OF PERSONS, AND SHOULD NOT BE RELIED UPON AS A SAFETY COMPONENT OR PROTECTIVE DEVICE FOR SUCH PURPOSES.

Please refer to separate catalogs for OMRON's safety rated products.

OMRON shall not be responsible for conformity with any standards, codes, or regulations that apply to the combination of products in the customer's application or use of the product.

At the customer's request, OMRON will provide applicable third party certification documents identifying ratings and limitations of use that apply to the products. This information by itself is not sufficient for a complete determination of the suitability of the products in combination with the end product, machine, system, or other application or use.

The following are some examples of applications for which particular attention must be given. This is not intended to be an exhaustive list of all possible uses of the products, nor is it intended to imply that the uses listed may be suitable for the products:

- Outdoor use, uses involving potential chemical contamination or electrical interference, or conditions or uses not described in this document.

- Nuclear energy control systems, combustion systems, railroad systems, aviation systems, medical equipment, amusement machines, vehicles, safety equipment, and installations subject to separate industry or government regulations.
- Systems, machines, and equipment that could present a risk to life or property.

Please know and observe all prohibitions of use applicable to the products.

NEVER USE THE PRODUCTS FOR AN APPLICATION INVOLVING SERIOUS RISK TO LIFE OR PROPERTY WITHOUT ENSURING THAT THE SYSTEM AS A WHOLE HAS BEEN DESIGNED TO ADDRESS THE RISKS, AND THAT THE OMRON PRODUCT IS PROPERLY RATED AND INSTALLED FOR THE INTENDED USE WITHIN THE OVERALL EQUIPMENT OR SYSTEM.

## **PERFORMANCE DATA**

Performance data given in this document is provided as a guide for the user in determining suitability and does not constitute a warranty. It may represent the result of OMRON's test conditions, and the users must correlate it to actual application requirements. Actual performance is subject to the OMRON Warranty and Limitations of Liability.

## **CHANGE IN SPECIFICATIONS**

Product specifications and accessories may be changed at any time based on improvements and other reasons.

It is our practice to change model numbers when published ratings or features are changed, or when significant construction changes are made. However, some specifications of the product may be changed without any notice. When in doubt, special model numbers may be assigned to fix or establish key specifications for your application on your request. Please consult with your OMRON representative at any time to confirm actual specifications of purchased products.

## **DIMENSIONS AND WEIGHTS**

Dimensions and weights are nominal and are not to be used for manufacturing purposes, even when tolerances are shown.

## **ERRORS AND OMISSIONS**

The information in this document has been carefully checked and is believed to be accurate; however, no responsibility is assumed for clerical, typographical, or proofreading errors, or omissions.

## **PROGRAMMABLE PRODUCTS**

OMRON shall not be responsible for the user's programming of a programmable product, or any consequence thereof.

## **COPYRIGHT AND COPY PERMISSION**

This document shall not be copied for sales or promotions without permission.

This document is protected by copyright and is intended solely for use in conjunction with the product. Please notify us before copying or reproducing this document in any manner, for any other purpose. If copying or transmitting this document to another, please copy or transmit it in its entirety.

## Meanings of Signal Words



The following signal words are used in this manual.

### ⚠ WARNING

Indicates a potentially hazardous situation which, if not avoided, will result in minor or moderate injury, or may result in serious injury or death. Additionally there may be significant property damage.

## Meanings of Alert Symbols

The following alert symbols are used in this manual

	Indicates general prohibitions for which there is no specific symbol.
	Indicates the possibility of laser radiation.
	Indicates the possibility of explosion under specific conditions.

### ⚠ WARNING

This product is not designed or rated for ensuring safety of persons.  
Do not use it for such purposes.



The camera with lighting emits visible light, which may adversely affect the eyes in rare instances.  
Do not look directly into the light emitted from the Camera. When the subject is a specular reflective object, protect your eyes from reflected light.



A lithium battery is built into the Controller and may occasionally combust, explode, or burn if not treated properly.  
Dispose of the Controller as industrial waste, and never disassemble, apply pressure that would deform, heat to 100 °C or higher, or incinerate the Controller.



## Precautions for Safe Use

The following points are important to ensure safety, so make sure that they are strictly observed.

### 1. Installation Environment

- Do not use the product in environments where it can be exposed to inflammable/explosive gas.
- To secure the safety of operation and maintenance, do not install the product close to high-voltage devices and power devices.
- Install the product in such a way that its ventilation holes are not blocked.
- Tighten mounting screws at the torque specified in this manual.

### 2. Power Supply and Wiring

- The voltage and AC power supply must be within the rated range (24 VDC  $\pm$ 10%).
- Reverse connection of the power supply is not allowed.
- Use the power supply within the rated load.
- High-voltage lines and power lines must be wired separately from this product. Wiring them together or placing them in the same duct may cause induction, resulting in malfunction or damage.
- Use the product within the power supply voltage specified in this manual.
- Use a DC power supply with safety measures against high-voltage spikes (safety extra low-voltage circuits on the secondary side).
- Tighten mounting screws at the torque specified in this manual.

### 3. Other

- Do not use this product in safety circuits associated with nuclear power and human life.
- Do not disassemble, repair, modify, deform by pressure, or incinerate this product.
- Dispose of this product as industrial waste.
- Connect the exclusive devices (Camera, Controller, Strobe Controller, Cable). The product might break down or malfunction if you use a part not included in the exclusive products.
- Should you notice any abnormalities, immediately stop use, turn OFF the power supply, and contact your OMRON representative.

### 4. Laws and Regulations, Standards

- This product complies with the following EC and EN directives:  
EC Directive No.89/336/EEC  
EN Standards EN61326: 1997+A1: 1998+A2: 2001+A3: 2003 (EMI: Class A)

## Precautions for Correct Use

Observe the following precautions to prevent failure to operate, malfunctions, or undesirable effects on product performance.

### 1. Installation Site

Do not install this product in locations subjected to the following conditions:

- Ambient temperature outside the rating
- Rapid temperature fluctuations (causing condensation)
- Relative humidity outside the range of 35 to 85%
- Direct vibration or shock
- Reflection of intense light (such as other laser beams, electric arc-welding machines, or ultra-violet light)
- Direct sunlight or near heaters
- Strong magnetic or electric field

Also, do not install this product in locations subjected to the following conditions to ensure its protective performance as described in the specifications:

- Presence of corrosive or flammable gases
- Presence of dust, salt, or iron particles
- Water, oil, or chemical fumes or spray, or mist atmospheres

### 2. Power Supply and Wiring

- When using a commercially available switching regulator, make sure that the FG terminal is grounded.
- If surge currents are present in the power lines, connect surge absorbers that suit the operating environment.
- Before turning ON the power after the product is connected, make sure that the power supply voltage is correct, there are no incorrect connections (e.g. load short-circuit) and the load current is appropriate. Incorrect wiring may result in breakdown of the product.
- Before connecting/disconnecting cables, make sure that the product is turned OFF. The product may break down if it is connected/disconnected while the power is ON.
- For cables, use only the exclusive products specified in this manual.

 p.14, p.15

- Use only combinations of the Camera, Controller and Strobe Controller specified in this manual. Using other combinations may cause malfunction or damage.
- Do not turn the power OFF in the following instances. Doing so will damage data that is in the process of being saved.
  - While data is being saved on the Controller
  - While data is being saved on the SD card
- The LCD panel has been made using precision technology, and sometimes a few pixels are missing in the panel. This is due to the structure of the LCD panel, and is not a malfunction.
- Do not remove the base from the Camera.

### 3. Maintenance and Inspection

Do not use thinner, benzene, acetone or kerosene to clean the Camera and Controller. If large dust particles adhere to the Camera, use a blower brush (used to clean camera lenses) to blow them off. Do not use breath from your mouth to blow the dust off. To remove dust particles from the Camera, wipe gently with a soft cloth (for cleaning lenses) moistened with a small amount of alcohol. Do not use excessive force to wipe off dust particles. Scratches to the Camera might cause error.

### 4. Ventilation Film

- Do not peel of the ventilation film or prod it with a sharp-pointed object. This might impair its protective structure.
- Do not cover the ventilation film. Doing so might cause the Camera's front panel to cloud.



## 5.Optional Lighting Connector

When the optional lighting is not connected, be sure to attach the connector cap. Otherwise, its protective structure might be impaired.

## 6.Camera's Connector Cap

When using only one camera, attach the connector cap to cameras that are not in use.

# Editor's Note

### ■ Meaning of Symbols

Menu items that are displayed on the Controller's LCD screen, and windows, dialog boxes and other GUI elements displayed on the PC are indicated enclosed by brackets "[ ]".

### ■ Visual Aids

**Important**

Indicates points that are important to achieve the full product performance, such as operational precautions.

**Note**

Indicates application procedures.



Indicates pages where related information can be found.

MEMO

# CONTENTS

## 1. BEFORE USE

<b>ZFX-C</b> .....	<b>14</b>
System Configuration .....	14
Part Names and Functions .....	16
<b>Mounting and Connecting Devices</b> .....	<b>19</b>
Installing Cameras .....	19
Installing the Controller .....	25
Connecting Devices .....	28
<b>Overview of Settings and Measurement</b> .....	<b>31</b>
Operation Modes .....	31
Outline of MENU mode .....	32
Measurement Items and Banks .....	33
Initializing Controller Settings .....	35
Saving Setup Data .....	36

## 2. BASIC OPERATIONS

<b>Inspection Setup and Measurement</b> .....	<b>38</b>
Setting Measurement Conditions - MENU Mode .....	38
Checking the Measurement Status - ADJ Mode .....	42
Starting Measurement - RUN Mode .....	42
<b>Troubleshooting</b> .....	<b>43</b>
Clear Images Cannot be Obtained .....	43
Measurement Target Cannot be Measured Accurately Due to Movement .....	43
To Output Measurement Values to a PC or PLC .....	44
To Output Position Information of Measurement Targets as Actual Coordinates .....	44

# 3.SETTING THE MEASUREMENT CONDITIONS

<b>Setting Measurement Items</b> .....	<b>46</b>
Shape Inspection .....	46
Pattern Search .....	46
Graphic Search .....	51
Flexible Search .....	55
Sensitive Search .....	58
Size Inspection .....	62
Area .....	62
Labeling .....	66
Edge Inspection .....	70
Position .....	70
Width .....	75
Count .....	79
Bright/Color Inspection .....	82
Bright .....	82
HUE .....	84
Inspection by Individual Application .....	87
Grouping .....	87
Defect .....	90
Image Adjustment .....	94
<b>Cameras/Lighting</b> .....	<b>98</b>
Shutter Speed .....	98
Gain Setting .....	98
Partial Function Settings .....	99
Image Rate .....	99
Light Control (Recipe Functions) .....	100
Calibration .....	101
<b>Registering Images</b> .....	<b>106</b>
<b>Position Correction</b> .....	<b>107</b>
<b>Additional Functions</b> .....	<b>109</b>
Calculation .....	109
Setting Reflection of Individual Results .....	112
Logging Monitor .....	113

## 4.FUNCTIONS USED DURING OPERATION

<b>Monitoring the Measurement Status - RUN Mode</b> .....	<b>116</b>
Displaying Measurement Information .....	116
Switching the Image Display Method .....	118
<b>Checking/Adjusting the Measurement - ADJ Mode</b> .....	<b>119</b>
Checking Measurement Status .....	119
Switching the Image Display Method .....	121
Using a Saved Image to Perform Re-measurement .....	121
Adjusting Measurement Conditions .....	122

## 5.ADDITIONAL FUNCTIONS

<b>Bank Settings</b> .....	<b>126</b>
Bank Data Operations .....	127
Bank Group Operations .....	127
<b>System Settings</b> .....	<b>128</b>
Camera Specifications .....	128
Communication Setup .....	128
Output Settings .....	132
Display Settings .....	134
Operation Settings .....	135
Measurement Control Conditions .....	137
Operation Conditions during Startup .....	138
Setting/Changing the Display Language .....	138
Setting/Changing the Date .....	139
Clearing Saved Images .....	139
<b>Tools</b> .....	<b>140</b>
Saving/Loading Data .....	140
SD Card Operations .....	141
Checking Density Distribution (Profile) .....	141
Checking the Communication Status with External Devices .....	142
Displaying the Controller Information .....	143

## 6.PARALLEL INTERFACE

<b>Connection</b> .....	<b>146</b>
Parallel Connector Specifications .....	146
<b>Internal Specifications</b> .....	<b>150</b>
<b>Signal I/O</b> .....	<b>152</b>
Input Signal .....	152
Output Signal .....	153
<b>Timing Charts</b> .....	<b>156</b>
Measurement (Handshaking OFF) .....	156
Measurement (Handshaking ON) .....	159
Commands Other than for Measurement .....	160
Signal Operation in terms of Measurement .....	161

## 7.APPENDICES

<b>Error Messages and Corrective Actions</b> .....	<b>166</b>
<b>List of Available Functions for Each Camera</b> .....	<b>167</b>
<b>AUTO Setting</b> .....	<b>168</b>
AUTO Setting of Measurement Items .....	168
AUTO Setting in Individual Adjustment Screens .....	169
<b>Specifications and External Dimensions</b> .....	<b>170</b>
Camera .....	170
Controller .....	176
Accessories & Options .....	178
<b>LED Safety</b> .....	<b>187</b>
<b>Requirements from Regulations and Standards</b> .....	<b>188</b>
Summary of Requirements to Manufactures .....	188
Summary of Requirements to User .....	190
Definitions of Laser Classification .....	191
<b>Basic Knowledge for Operation</b> .....	<b>192</b>
<b>Menu List</b> .....	<b>196</b>
<b>INDEX</b> .....	<b>199</b>
<b>How Color Images are Processed</b> .....	<b>201</b>
Color Filter .....	202
Color Pickup .....	204
Hue, Saturation and Brightness Value .....	206
<b>Version Upgrade Information</b> .....	<b>207</b>
<b>Revision History</b> .....	<b>208</b>

# BEFORE USE

---

<b>ZFX-C</b>	<b>14</b>
System Configuration	14
Part Names and Functions	16
<b>Mounting and Connecting Devices</b>	<b>19</b>
Installing Cameras	19
Installing the Controller	25
Connecting Devices	28
<b>Overview of Settings and Measurement</b>	<b>31</b>
Operation Modes	31
Outline of MENU mode	32
Measurement Items and Banks	33
Initializing Controller Settings	35
Saving Setup Data	36

# ZFX-C

The ZFX-C is a series of vision sensors that senses objects by their “surfaces.” Objects captured by a camera can be checked on the built-in 3.5-inch LCD monitor.

## System Configuration

Basically, the ZFX-C is configured by the Controller and the camera.

Other external devices can be selected to be used in combination with the ZFX-C according to the user’s specific requirements.

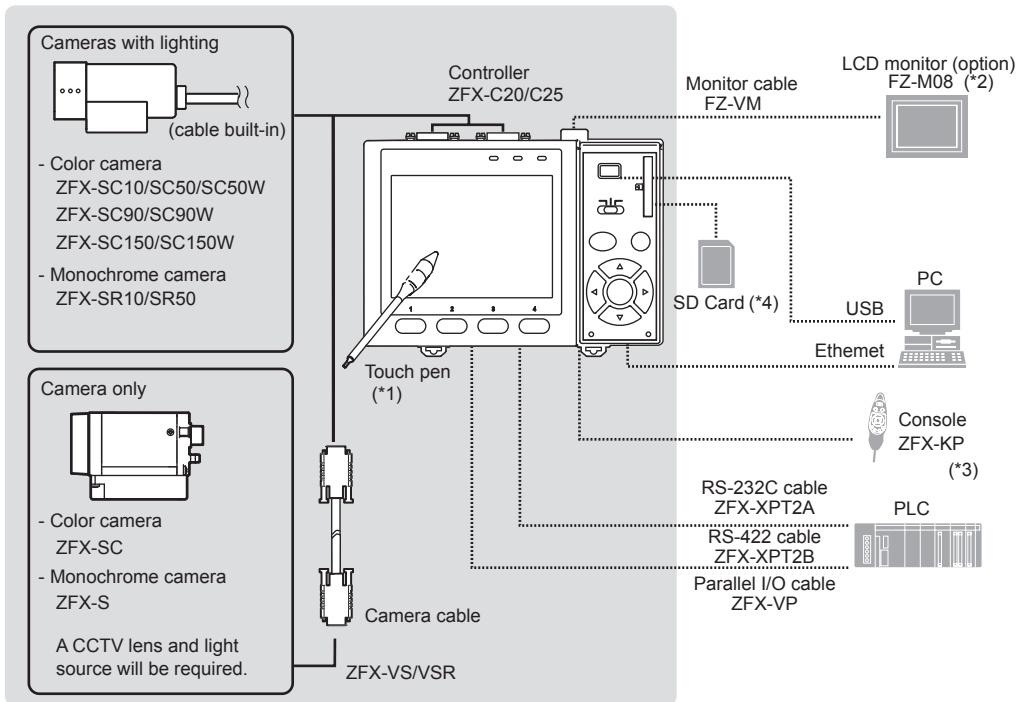

\*1: The Touch Pen (ZFX-TP) is supplied with the Controller.

\*2: The same image as in the Controller's LCD monitor can be displayed in the LCD monitor (option).

\*3: The console can be used instead of the Controller's keys and menu buttons.

\*4: Conforms to the SD Card “Physical layer specifications 1.01.”

File format: FAT16



## Options

### Extension cable for connecting cameras and the Controller

Cameras with lighting

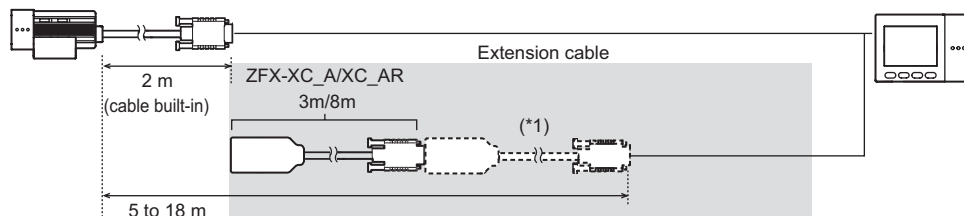

Camera only

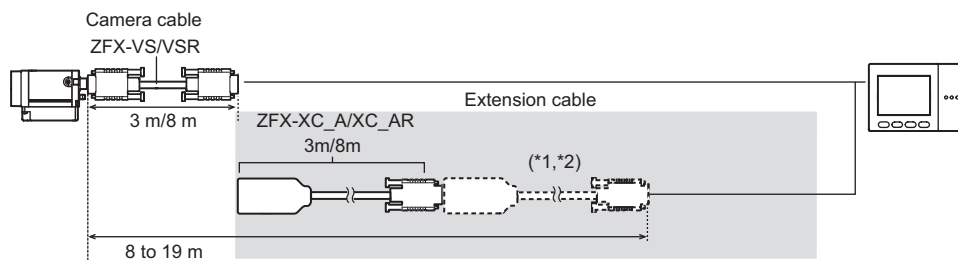

\*1: Up to two ZFX-XC\_A/XC-AR can be connected between the camera cable and the Controller.

\*2: Two ZFX-XC8A cannot be connected to each other when used with ZFX-VS (8 m.)

### Optional lighting

The following optional lighting can be connected to ZFX-SC50/SC50W/SC90/SC90W.

- Bar lighting ZFV-LTL01
- Bar double-lighting ZFV-LTL02
- Bar low-angle lighting ZFV-LTL04
- Light Source for Through-beam Lighting ZFV-LTF01

# Part Names and Functions

## Cameras

### Cameras with lighting

ZFX-SC10/SR10/SR50

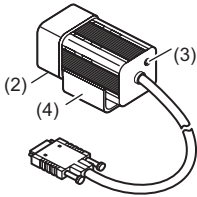

ZFX-SC50/SC50W

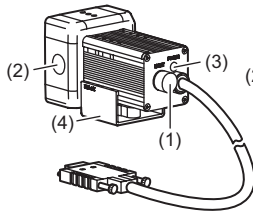

ZFX-SC90/SC90W

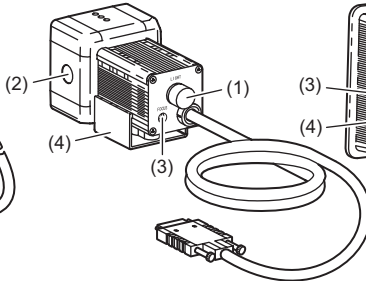

ZFX-SC150/SC150W

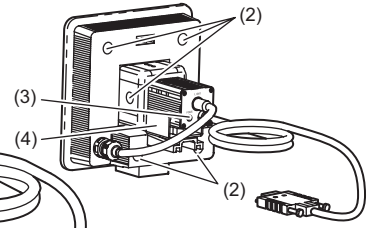

### Camera only (C-mount type)

ZFX-S/SC

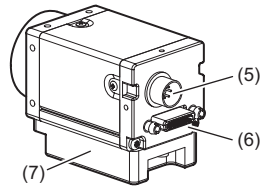

Name.	Description
(1)Optional lighting connector	This connector is used to connect an optional lighting. (ZFX-SC50/SC50W/SC90/SC90W)  <b>Important</b> When no optional lighting is used, make sure that the connector is covered with the cap. If not, water-resistant performance will be deteriorated.
(2)Ventilation film	This film prevents the front panel from condensation.  <b>Important</b> <ul style="list-style-type: none"> <li>Do not peel off or probe the ventilation film with a sharp-pointed object. If you do that the protective structure rating may no longer be satisfied.</li> <li>Do not cover the ventilation film rating. Doing so might cause the front panel to be condensed.</li> </ul>
(3)Focus adjustment control	This control is used for adjusting the focus of the image.
(4)Mounting fixture	This mounting fixture is used for fastening the camera when installing it. The mounting fixture can be installed on all of the four mounting surfaces.
(5)Lighting connector	This connector is used to connect external lighting (Strobe Controller: 3Z4S-LT MLEK-C100E1TSX).
(6)Camera cable connector	This connector is used for connecting to the Controller via a camera cable (ZFX-VS/VSR).
(7)Camera mounting base	This camera mounting base is fastened with screws to hold the camera in place. The camera mounting base can be installed on all of the four mounting surfaces.

## Controller

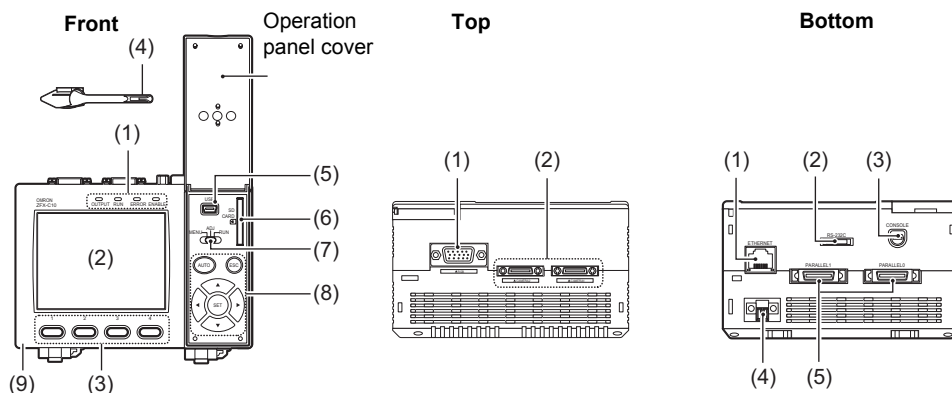

1 BEFORE USE

### Front





Name	Function
(1) Indicator	<p>“Measuring” indicator (RUN): Lights in green when in the RUN mode.</p> <p>Error indicator (ERROR): Lights in red when an error occurs.</p> <p>Judgment indicator (OUTPUT): Lights in orange when the judgment result is OK or NG according to the setting. (Note)</p> <p>Trigger indicator (ENABLE): Lights in blue when the ZFX-C is ready for the measurement trigger input.</p>
(2) LCD monitor/touch panel	The LCD monitor displays setup menus and images captured from the cameras. Various settings can be made on the touch panel by tapping menu buttons in the LCD monitor using the touch pen.
(3) Function keys	Specific functions are allocated to the Function keys.
(4) Touch pen	The touch pen is used to operate the touch panel. This pen can be attached to the Controller by tying its strap to the strap holder for the touch pen.
(5) USB port	This port is for connecting to a personal computer via a USB cable.
(6) SD card slot	<p>This slot is for inserting the SD Card.</p> <p>When the SD Card is inserted, the SD mark is displayed at the top right of the screen.</p> <p>Blue SD mark: The SD card is inserted but not being accessed.</p> <p>Red SD mark: The SD card is being accessed.</p>
(7) Mode switch	<p>This switch selects the operation mode.</p> <p>MENU: Select this mode when setting measurement conditions.</p> <p>ADJ: Select this mode when adjusting setting parameters as necessary referencing the image and values displayed on the LCD monitor during continuous test measurement (measurement without measurement data output to external devices).</p> <p>RUN: Select this mode when performing measurement.</p>
(8) Control keys	These keys are used to perform operations without the use of the touch pen.
(9) Strap holder for touch pen	This holder is for attaching the touch pen.

Note: The judgment result is output to the OR signal via the parallel interface.

## Top

Name	Function
(1) Monitor connector	This connector is for connecting to the LCD monitor (option) via a monitor cable.
(2) Camera connector	This connector is for connecting to a camera.

## Bottom

Name	Function
(1) Ethernet port	This port is for connecting to a personal computer via a 100Base-TX/10Base-T cable.
(2) RS-232C/422 connector	This connector is for connecting to a PLC via an RS-232C or an RS-422 cable.  p.14
(3) Console connector	This port is for connecting to the Console.  p.14
(4) Power connector	This connector is for connecting to the DC power supply.  p.28
(5) Parallel port	This port is for connecting to devices such as a PLC using the parallel cable.  p.14, p.146

### Important

- Attach the connector caps to connectors that are not in use to prevent dust or dirt from getting inside the connectors and to prevent the Controller from static electricity.

# Mounting and Connecting Devices

## Installing Cameras

### Camera with Lighting

#### Optical chart

BEFORE USE

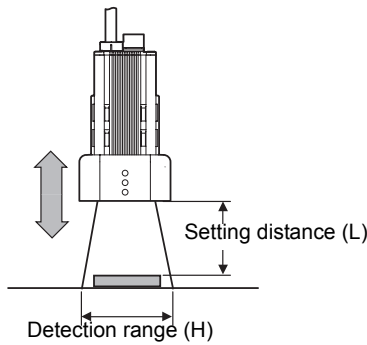

#### ► ZFX-SC10/SR10

Setting distance L (mm)

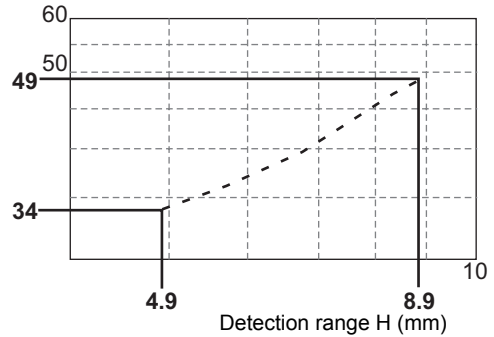

#### ► ZFX-SR50

Setting distance L (mm)

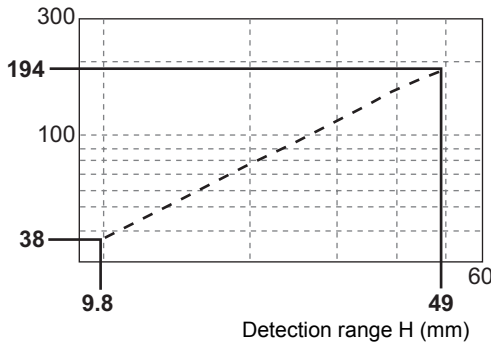

#### ► ZFX-SC50/SC50W

Setting distance L (mm)

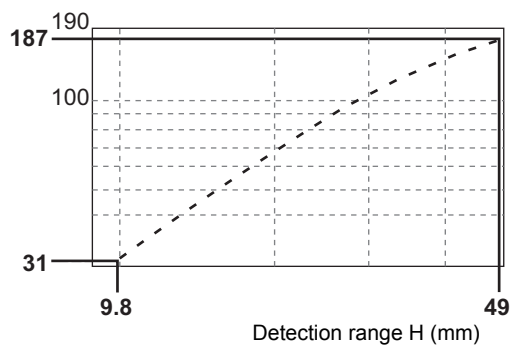

#### ► ZFX-SC90/SC90W

Setting distance L (mm)

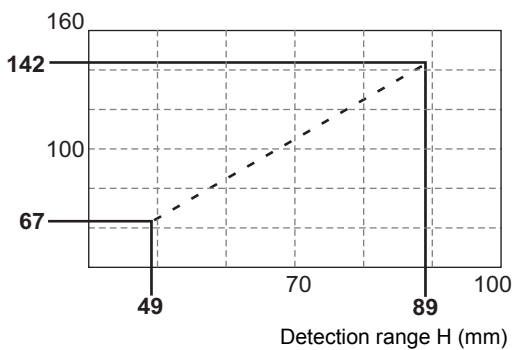

#### ► ZFX-SC150/SC150W

Setting distance L (mm)

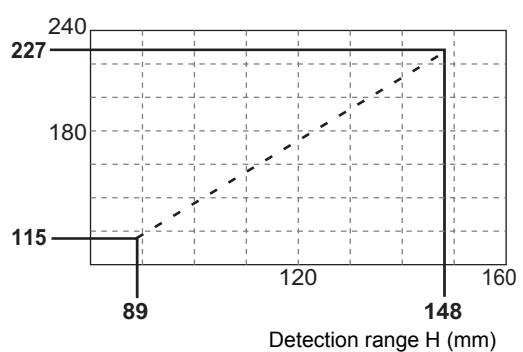

## Note

- The lens has a fixed focal point. The actual detection range and focal point vary from lens to lens, so adjust the distance to the measurement target after replacing the lens or camera.
- The camera mounting distance listed in the following tables is an approximate value. Mount the Camera so that the distance to the measurement target can be adjusted easily.
- If the object size and detection range are incompatible, use a combination of a camera (without lighting), standard CCTV lens and light source.

 Camera Only p.22

## Installing the mounting fixture

The mounting fixture can be installed on all of the four mounting surfaces.

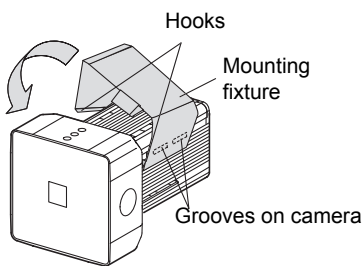

**1** Align the two hooks on one side of the mounting fixture with the two grooves on the camera body.

**2** Push the other hook down until it is snapped into place.  
Make sure that the mounting fixture is firmly fixed on the camera.

**3** Fasten the mounting fixture at the mounting location with screws.

Tightening torque

M4: 1.2 N•m

1/4"-20 UNC: 2.6 N•m

### ► Removal procedure

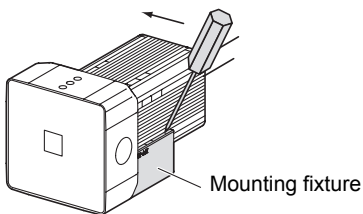

**1** Insert a screwdriver into the gap (one of the two gaps) between the mounting fixture and the camera case, and remove the mounting fixture.

## Adjusting the camera focus

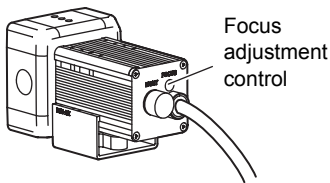
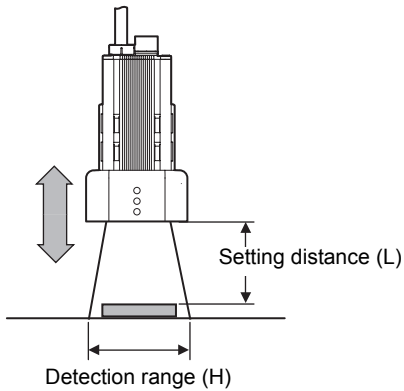

### 1 Adjust the distance between the camera and the measurement target and fasten the camera.

Refer to the optical chart and set the camera in a position so that the area to be checked is within the detection area (LCD monitor).

 Optical chart p.19

### 2 Turn the focus adjustment control to the left and right to adjust the focus.

#### Note

First turn the focus adjustment control slightly to the left and right, to make sure that the Focus adjustment control is not at the upper or lower limit positions. Do not exert unnecessary force to turn the control at the upper or lower limit positions as this might damage the control.

(For ZFX-SC90\_/SC150\_, the control stops turning at the nearest position. It turns free at the farthest position.)

# Camera Only

## Optical chart

The values in the following chart are approximations, and the Camera must be adjusted after it is mounted.

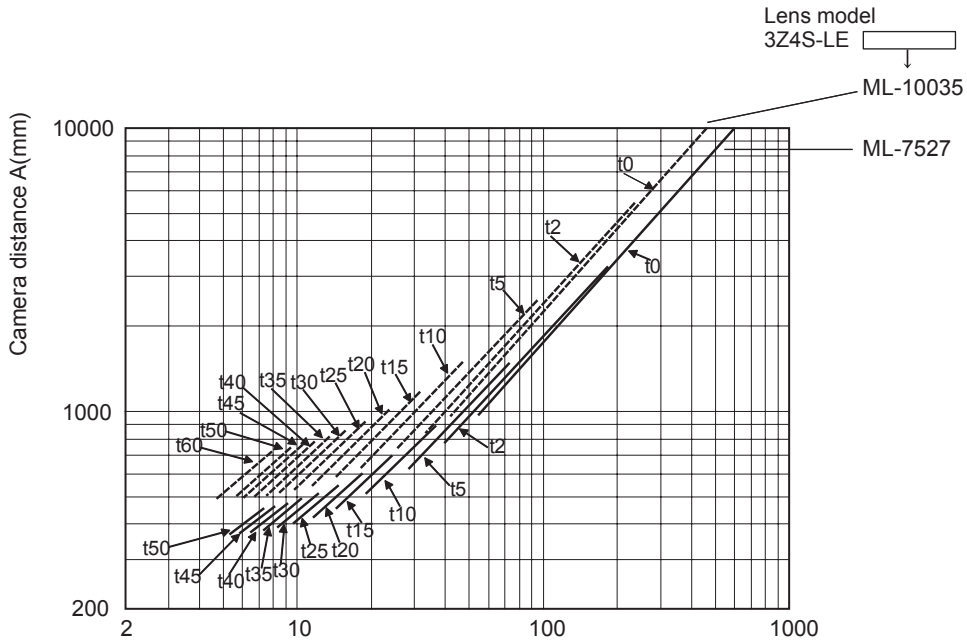
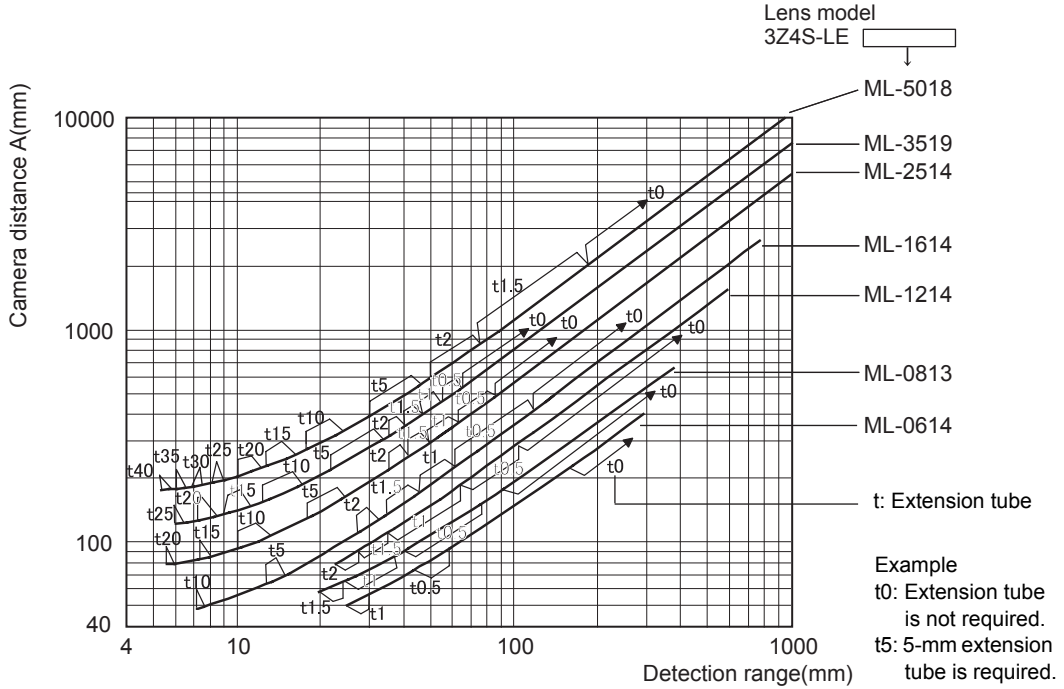



The X axis of the optical chart shows detection range L (mm), and the Y axis shows the camera distance A (mm). The curves on the optical chart show the relationship between the detection range and camera distance for each CCTV lens. The values are significantly different for each lens, so double-check the model of the lens before using the graph. The “t” values indicate the lengths of the Extension Tubes. The value “t0” shows the case where an Extension Tube is not required and the value “t5.0” shows the case where a 5-mm Extension Tube is used.

► Example

When a 3Z4S-LE ML-5018 CCTV Lens is being used and a detection range of 40 mm is required at the measurement target, a camera distance of 500 mm and 5-mm Extension Tube are required.

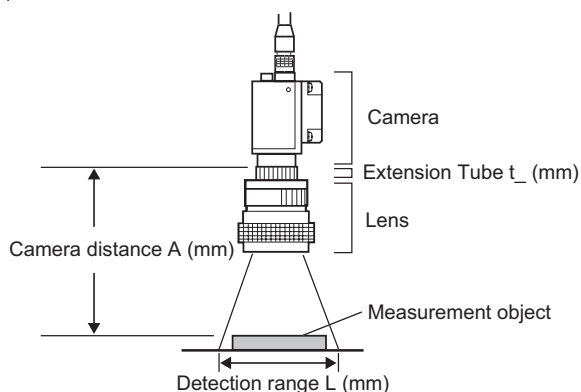

### Lenses and lens diameters

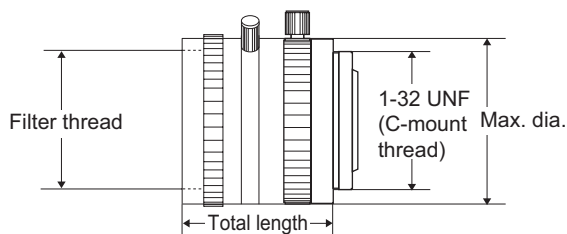

Lens	Focal length	Brightness	Maximum outer diameter	Total length	Filter size
3Z4S-LE ML-0614	6 mm	F1.4	30 mm dia.	30 mm	M27 P0.5
3Z4S-LE ML-0813	8 mm	F1.3	30 mm dia.	34.5 mm	M25.5 P0.5
3Z4S-LE ML-1214	12 mm	F1.4	30 mm dia.	34.5 mm	M27 P0.5
3Z4S-LE ML-1614	16 mm	F1.4	30 mm dia.	24.5 mm	M27 P0.5
3Z4S-LE ML-2514	25 mm	F1.4	30 mm dia.	24.5 mm	M27 P0.5
3Z4S-LE ML-3519	35 mm	F1.9	30 mm dia.	29 mm	M27 P0.5
3Z4S-LE ML-5018	50 mm	F1.8	32 mm dia.	37 mm	M30.5 P0.5
3Z4S-LE ML-7527	75 mm	F2.7	32 mm dia.	42.5 mm	M30.5 P0.5
3Z4S-LE ML-10035	100 mm	F3.5	32 mm dia.	43.9 mm	M30.5 P0.5

## Extension Tubes

One or more Extension Tubes can be inserted between the lens and the Camera to focus the Camera image. Use a combination of one or more of the seven tubes to achieve the required length.

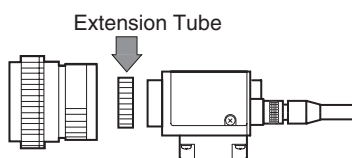

Model	Maximum outer diameter	Length
3Z4S-LE ML-EXR	31 dia.	Set of 7 tubes Length: 40 mm    20 mm    10 mm    5 mm    2 mm    1 mm    0.5 mm
		

### Important

- Do not use the 0.5-mm, 1.0-mm and 2.0-mm Extension Tubes attached to each other. Since these Extension Tubes are placed over the threaded section of the Lens or other Extension Tube, the connection may loosen when more than one 0.5-mm, 1.0-mm or 2.0-mm Extension Tube are used together.
- Reinforcement may be required for combinations of Extension Tubes exceeding 30 mm if the Camera is subject to vibration.

## Installing the Camera Mounting Base

The camera mounting base mounted on the bottom of the camera can be installed on all of the four mounting surfaces. To change the mounting surface, remove the three mounting screws (M2 x 6) from the camera.

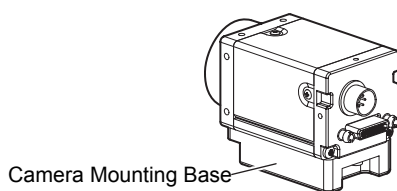

- Tightening torque when fastening the camera mounting base at the mounting location  
M4: 1.2 N•m  
1/4"-20 UNC: 2.6 N•m

# Installing the Controller

## Installation Precautions

To improve heat radiation, install the Controller only in the orientation show below.

Right

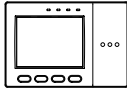

Do not install the Controller in the following orientations.

Wrong

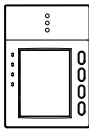

Wrong

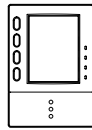

### Important

- Install the Controller so that the distance between the Controller and other devices is at least the dimensions shown in the figure below to improve the ventilation.

When installing Controller only:

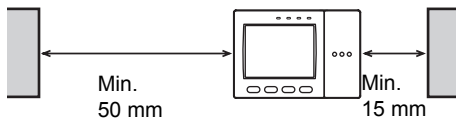

When installing the Controller With the Exhaust Unit attached:

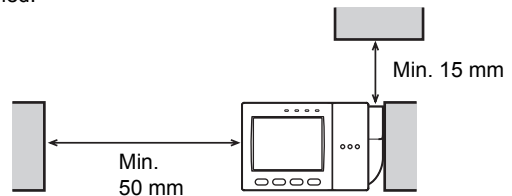

- Keep the ambient temperature less than 50 °C. If the ambient temperature is higher than 50 °C, install a fan forced cooling system or an air conditioner to keep the temperature lower than 50 °C.
- Avoid mounting on a panel, in which high-voltage emitting devices are installed to prevent ZFX-C operation from being affected by noise.
- Allow at least 10 m between the Controller and power lines to keep noise at a low level in the operating environment.

## Installing on the DIN Track

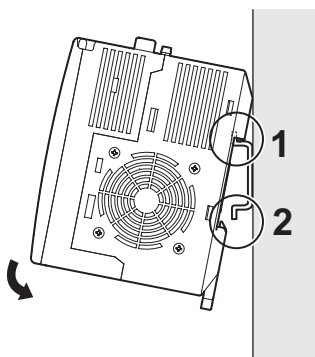

- 1** Hook the Controller's upper hook onto the DIN track.
- 2** Push the Controller down onto the DIN track until its lower hook is snapped into place.

### Important

- Attach the End Plate (sold separately) to both sides of the Controller on the DIN track.
- Attach the Exhaust Unit (supplied) to the Controller when installing other devices adjacently on the same DIN track as the Controller.  p.20

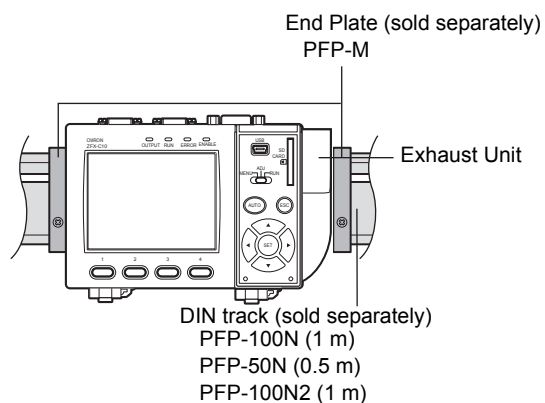

## Removing procedure

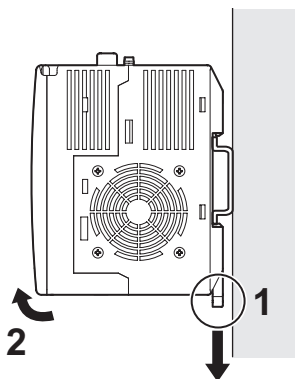

- 1** Pull the Controller's lower hook downwards.
- 2** Lift up the Controller from its bottom to remove it from the DIN track.

## Mounting on a Panel

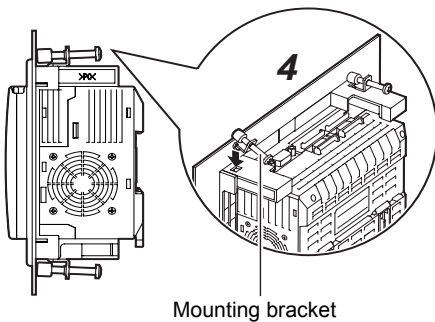
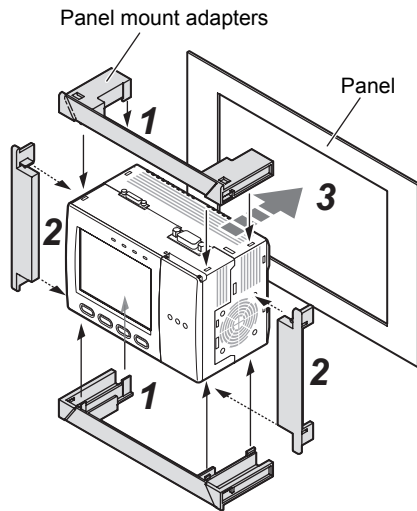

- 1** Install the long Panel Mount Adapters on the four holes on the Controller.
- 2** Install the short Panel Mount Adapters on the two holes on the long Panel Mount Adapter.
- 3** Install the Controller with Mount Adapters attached onto the panel from the front.
- 4** Hook the hooks of the mounting bracket onto the two holes (two each at top and bottom) of the longer Mount Adapters and tighten the screws.  
Tightening torque: 1.2 N·m.
- 5** Make sure that the Controller is firmly fixed on the panel.

1 BEFORE USE

# Connecting Devices

## Connecting the Controller to the Power Supply

Use a power supply that meets the following specifications.

Item	Specification
Power supply voltage	Approx. 24 VDC (21.6 to 26.4 VDC)
Output current	1.5 A min.
Recommended power supply	S8VS-06024 (24 VDC, 2.5 A)
Recommended electric wire size	0.14 to 1.5 mm <sup>2</sup> (max. 1 m)

### Important

Use a DC power supply with countermeasures against high voltages (safe extra low-voltage circuits on the secondary side). If the system must meet UL standards, use a UL class II power supply.

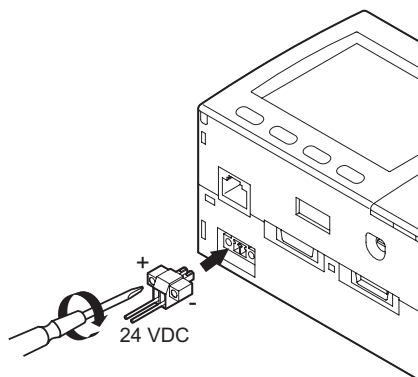

- 1** Loosen the two screws on the top of the Power connector (male) using a flat-blade screwdriver.
- 2** Insert the DC power terminal (wire) into the Power connector (male) and tighten the two screws on the top of the Power connector to fasten the power terminal with the screwdriver.  
Tightening torque: 0.22 to 0.25 N•m.
- 3** Plug the Power connector (male) into the Controller's Power connector (female).
- 4** Tighten the two screws on the left and right of the Power connector (male) with the screwdriver to fasten it.  
Tightening torque: 0.22 to 0.25 N•m.

## Attaching Ferrite Cores

Attach ferrite cores (supplied) to both ends of the camera's cable and the Controller's power cable, respectively.

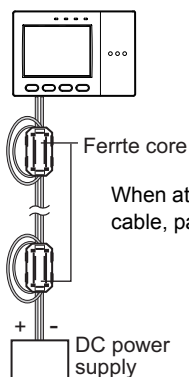
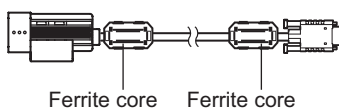

When attaching ferrite cores to the Controller's power cable, pass the cable once through each ferrite core.

## Connecting the Camera to the Controller

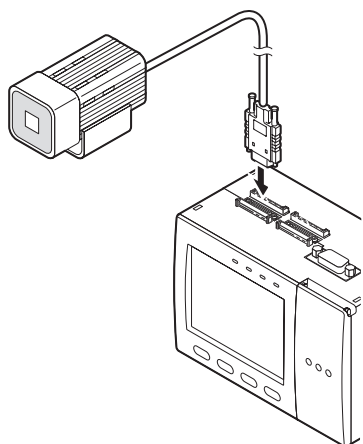

**1** Insert the camera's connector into the Controller's Camera connector.

**2** Tighten the two fastening screws of the Controller's Camera connector.

Tightening torque: 0.15 N•m.

### Important

- Do not touch the terminals inside the connector.
- Fasten the connector while making sure that it is not subjected to vibration or shock.
- Do not mount the Controller in such a way that a load is steadily applied on the connector, for example, with tension applied to the cables.

 To extend the installation distance between cameras and the Controller, see p.15

## Disconnection procedure

Loosen the fastening screws (two locations) to unlock the camera's cable, and then pull the camera's cable connector straight out.

### Important

- Be sure to hold the connector of the camera to disconnect it. Failure to do so may damage the camera's cable.
- Do not touch the terminals inside the connector.

## Connecting the Optional Lighting to the Camera

The optional lighting can be mounted to the rear connector of the camera (ZFX-SC50\_/SC90\_) with a single motion. Since the power is supplied from the camera side, no power supply is required for the optional lighting.

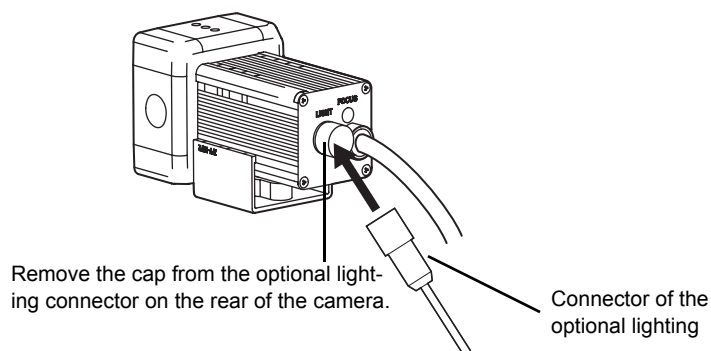

## Attaching the Exhaust Unit to the Controller

Attach the Exhaust Unit (supplied) to the Controller when installing other devices next to the Controller on the same DIN track. The Exhaust Unit also serves as the Touch Pen Holder

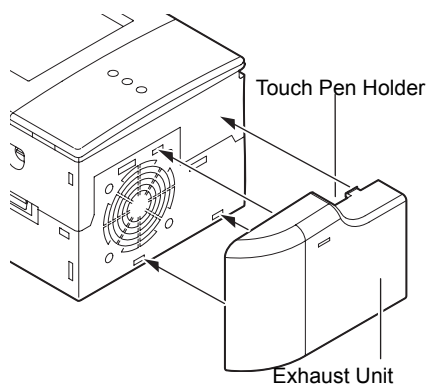

- 1 Attach the Exhaust Unit to the four mounting holes on the Controller.**



# Overview of Settings and Measurement

## Operation Modes

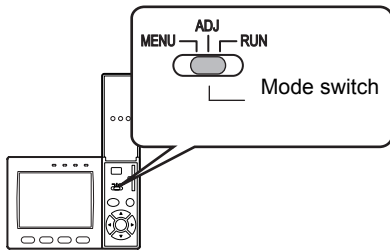

The ZFX-C has the following three modes. Switch to the desired mode before you start operation. To switch the operation mode, use the mode switch.

Mode	Description	
MENU mode	This mode is for setting the measurement conditions. The easy-to-follow icon-based display allows operations to be performed intuitively.	<p>Top Screen</p>
ADJ mode	This mode is for checking the measurement status and adjusting conditions. Measurement results are only displayed on the monitor and are not output.	<p>Top Screen</p>
RUN mode	This mode is used for performing actual measurement. Measurement results are displayed on the monitor and output.	<p>Top Screen</p>

# Outline of MENU mode

The MENU mode is broadly divided into three levels. The icons used for basic setup are displayed in the center.

Use icons other than those in the center whenever required.

## Top Menu

These menus are displayed when the Controller is turned on.

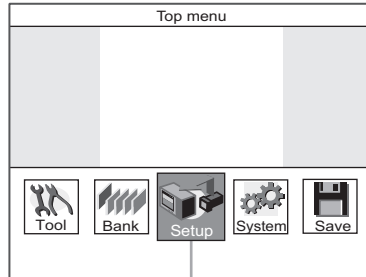

## Setup Menu

These menus are used for setting measurement conditions.

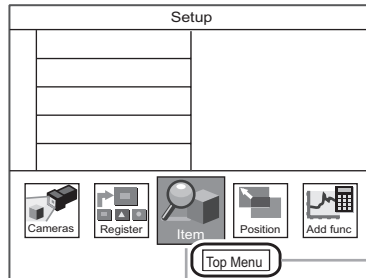

## Measurement item Menu

This selects measurement items and sets the measurement region. Up to 128 measurement regions can be set.

Select measurement item

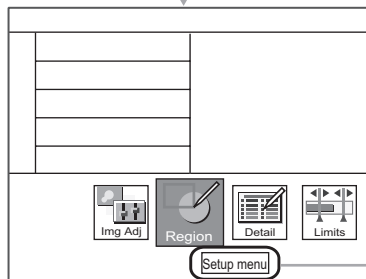

# Measurement Items and Banks

## Measuring Multiple Locations

Up to 128 locations in a single measurement image can be measured. A measurement type is called an "item," and desired measurement types are assigned to items 0 to 127.

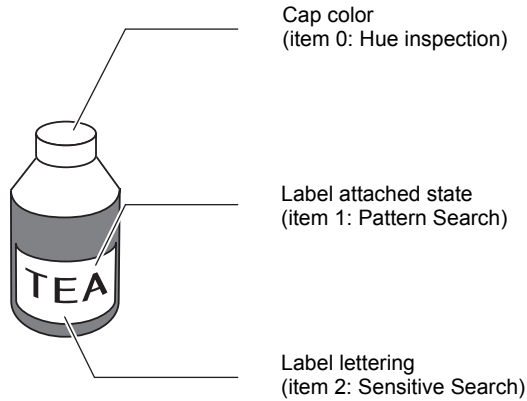

## Data for Change of Device Setup

If you register bank data for each individual product, you can reduce the time required for changing the device setup as all you need to do is to select different bank data to change the measurement conditions.

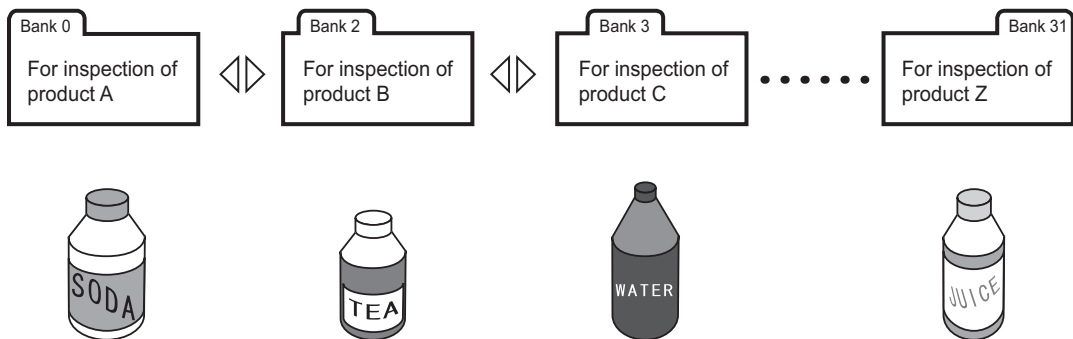

## Relationship between Items and Bank Data

Up to 128 items can be registered to a single bank data. Up to 32 bank data can be set to and saved on the ZFX.

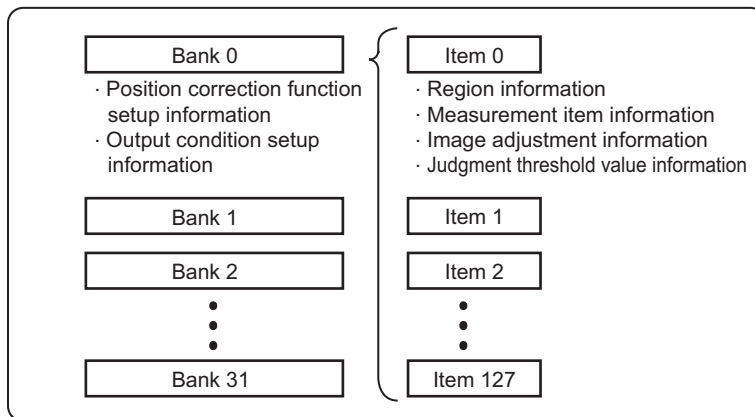

### Note

- If you use the bank group function, you can set up to 1024 banks.



Bank Settings p.126

- Bank and items can be given any name up to 16 characters.  
Bank and item names make it easier to recognize which measurement is being performed when multiple items and banks have been set.

# Initializing Controller Settings

## Important

The settings of all banks and system settings (excluding the display language setting) are initialized regardless of the currently selected bank No. To save the settings, back them up to a SD card before performing initialization.

 Saving/Loading Data p.140

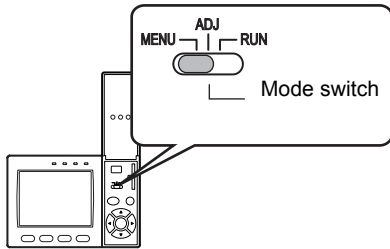

- 1** Switch to the [MENU] mode.  
The top screen is displayed.

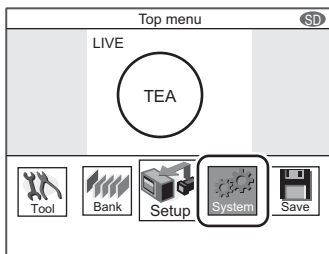

- 2** Select the [System] icon.

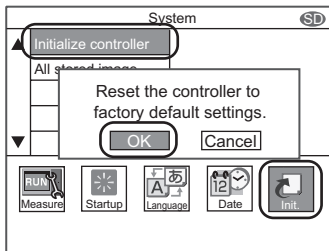

- 3** Select the [Init] icon.
- 4** Select [Initialize controller].
- 5** Select [OK].

# Saving Setup Data

After you have set the measurement conditions, be sure to save the setup data.

## Important

All settings will be deleted if you turn the power OFF without saving the data.

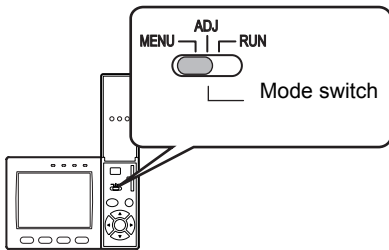

- 1** Switch to the [MENU] mode.  
The top screen is displayed.

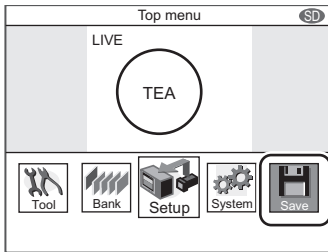

- 2** Select the [Save] icon.

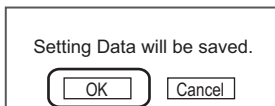

- 3** Select [OK].

## Note

### Data Saved on the Controller

Bank settings and system settings are saved internally on the Controller. Image data is not saved on the Controller. Save image data on the SD card.

### When Using the Bank Group Function

Bank data that is set to bank group 0 is saved internally on the Controller. When the bank data of bank groups 1 to 31 is saved, the bank data on the SD card is overwritten with the bank data of bank groups 1 to 31.

# BASIC OPERATIONS

---

<b>Inspection Setup and Measurement</b>	<b>38</b>
Setting Measurement Conditions - MENU Mode	38
Checking the Measurement Status - ADJ Mode	42
Starting Measurement - RUN Mode	42
<b>Troubleshooting</b>	<b>43</b>
Clear Images Cannot be Obtained	43
Measurement Target Cannot be Measured Accurately Due to Movement	43
To Output Measurement Values to a PC or PLC	44
To Output Position Information of Measurement Targets as Actual Coordinates	44

# Inspection Setup and Measurement

The following describes the flow of basic setup using, as an example, inspection of whether different types of objects are mixed in.

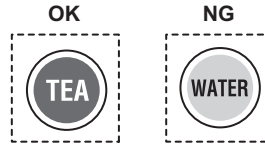
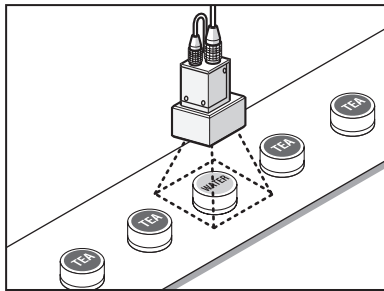

## Setting Measurement Conditions - MENU Mode

On the ZFX, a 3-step operation completes basic inspection setup.

### step1

Selecting measurement items

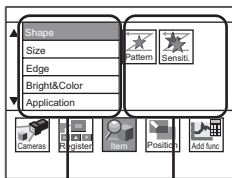

Measurement type group

Measurement items

### step2

Setting measurement regions

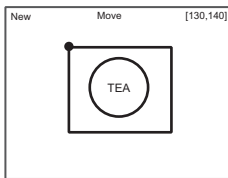

Enclose the desired measurement area.

### step3

Executing automatic setting

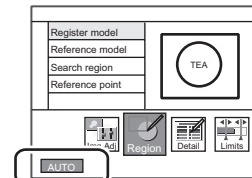

The optimum measurement conditions are automatically set just by selecting [AUTO]. Measurement conditions can also be checked and changed.



step **1** Selecting measurement items

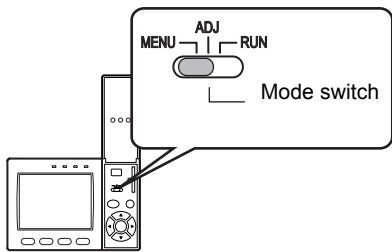

**1** Switch to the **MENU** mode.  
The top screen is displayed.

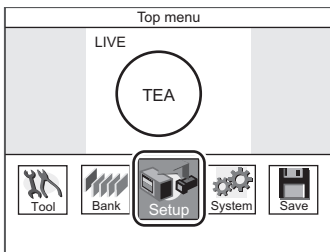

**2** Select the **[Setup]** icon.

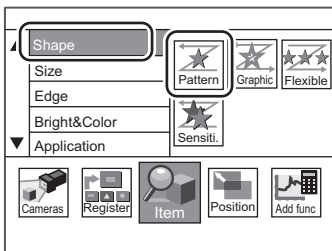

**3** Select **[Shape]**.

**4** Select the **[Pattern]** icon.

**Note**

For details on types of measurement items, see "Setting Measurement Conditions" in Chapter 3.

step **2** Setting measurement regions

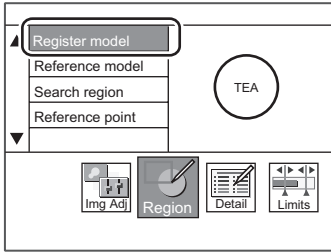

**1** Select [Register model].

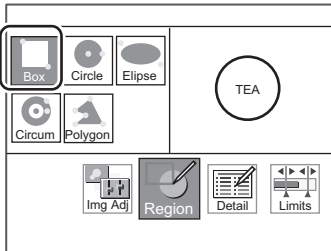

**2** Select [Box].

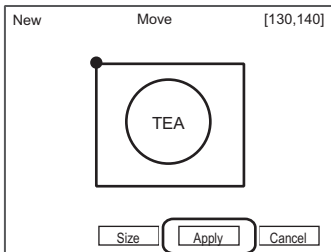

**3** Enclose the desired measurement area.

First, move the region. Next, select [Size] and apply the size.

**Note**

The location of the region can be changed or the region resized by the amount of drag movement if you drag anywhere on screen. (The drag start position need not be the line of the region.) To set a region on top of [Cancel] or other buttons at the bottom of the screen, drag somewhere else on screen.

 Setting the Region p.194

**4** Select [Apply].

step **3** Executing automatic setting

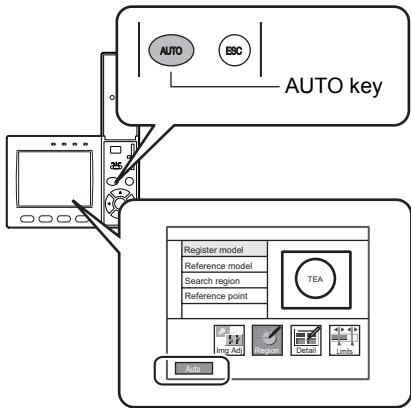

**1** Either press the **AUTO** key on the controller or select **[AUTO]** on screen.

**Note**

When the automatic setting is executed, the following parameters are set to their optimum values.

- Img Adj (filter setup)
- Limits (Differs according to measurement item.)
- Detail (Differs according to measurement item.)

Automatically made settings can be checked in each of the setup screens.

AUTO Setting p.168

# Checking the Measurement Status - ADJ Mode

Check whether or not measurement can be performed accurately under the conditions you have set, and adjust threshold values. Measurement results are only displayed on screen and are not output to external devices.

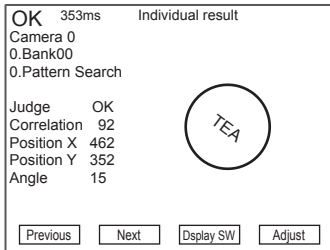
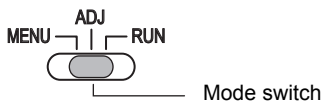

## 1 Select the ADJ mode.

The results of continuous measurement are displayed on screen. Make sure that measurement can be performed accurately and stably.

### Note Startup Adjustment

Up to 100 images can be saved while you are temporarily running the Controller in the RUN mode. Switch to the ADJ mode and read the saved images. Parameters matched to variation, etc. of the measurement object can be adjusted in this state as they are.

- Using a Saved Image to Perform Re-measurement p.121
- Adjusting Measurement Conditions p.122

# Starting Measurement - RUN Mode

When you have checked the measurement conditions you have set, use the RUN mode to perform measurement. In the RUN mode, measurement results are also output to external devices.

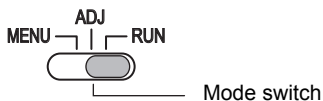

## 1 Select the RUN mode.

## 2 Input the trigger.

Measurement is executed.

Input the trigger using the SET and UP keys.

### Note Switching display content

In the RUN mode, you can switch the display content to check various information.

- Displaying Measurement Information p.116

### Important

After you have set the measurement conditions, be sure to save the setup data. All settings will be deleted if you turn the power OFF without saving the data.

- Saving Setup Data p.36

# Troubleshooting

## Clear Images Cannot be Obtained

Measurement sometimes cannot be performed successfully (e.g. measurement image is dark or contrast is low) depending on the characteristics of the measurement target. Sharp images can be obtained by applying filtering, or performing correction and adjustment to remedy the trouble.

Trouble	Remedy	Reference
Poor lighting	The recipe method light control settings can be used. You can set the lighting just by selecting the image that meets your specific requirements from the thumbnails of images automatically taken under different lighting patterns.	p.100
Low contrast	You can apply filters, such as "Sharpen", to the image to enhance the boundaries between shadow and highlight areas.	p.96
Uneven image	<ul style="list-style-type: none"><li>You can apply filters, such as "Smooth", to the image to smooth out unevenness in the image.</li><li>White parts of the image can be corrected to be reproduced appropriately by adjusting the white balance.</li></ul>	p.96, p.128
Dark image	You can raise the camera's sensitivity or lengthen the shutter time to make the image brighter.	p.98, p.100

## Measurement Target Cannot be Measured Accurately Due to Movement

When the measurement target is moving (e.g. its position or orientation are not fixed), it moves out of the preset measurement region, which prevents accurate measurement. The ZFX-C is provided with a "position shift correction function" that corrects the position shift of measurement regions such as this before performing measurement. The position shift correction function enables measurement targets whose position or orientation is not fixed to be measured accurately.

 Position Correction p.107

When setting the measurement region (reference image)

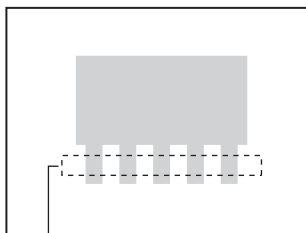

Measurement region

When the measurement target moves out of position

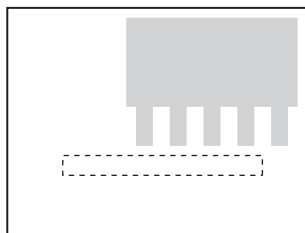

The position of the measurement target is measured after the measurement region is shifted by the amount of position shift.

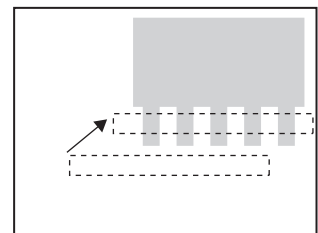

## To Output Measurement Values to a PC or PLC

Measurement values and judgment results can be output to a personal computer, PLC or other external device. Set the items to output and the output destination.

The following data can be output.

Output Item	Output Destination
Data (measurement values)	Serial interface (RS-232/RS-422, USB)
	Parallel interface
	SD card
Judgment	Parallel interface

-  • Setting Output Content p.132
- Assigning the Data Output Destination p.133

## To Output Position Information of Measurement Targets as Actual Coordinates

As the controller default, measurement values are output in pixel units and camera coordinates. You can convert measurement results in pixels to actual dimensions ( $\mu\text{m}$  or  $\text{mm}$ ) or actual coordinates for output by enabling the calibration function.

-  Calibration p.101

# SETTING THE MEASUREMENT CONDITIONS

<b>Setting Measurement Items</b>	<b>46</b>
Shape Inspection	46
Pattern Search	46
Graphic Search	51
Flexible Search	55
Sensitive Search	58
Size Inspection	62
Area	62
Labeling	66
Edge Inspection	70
Position	70
Width	75
Count	79
Bright/Color Inspection	82
Bright	82
HUE	84
Inspection by Individual Application	87
Grouping	87
Defect	90
Image Adjustment	94
<b>Cameras/Lighting</b>	<b>98</b>
Shutter Speed	98
Gain Setting	98
Partial Function Settings	99
Image Rate	99
Light Control (Recipe Functions)	100
Calibration	101
<b>Registering Images</b>	<b>106</b>
<b>Position Correction</b>	<b>107</b>
<b>Additional Functions</b>	<b>109</b>
Calculation	109
Setting Reflection of Individual Results	112
Logging Monitor	113

# Setting Measurement Items

## Shape Inspection

### Pattern Search

Register an image pattern in beforehand as a model, and search for parts that most resemble an already registered model. The correlation indicating how much parts resemble each other, the position of the measurement target, and their angle can be output. Use this function to check for whether different-type products are mixed in, or to calculate the position of the measurement target.

Setup

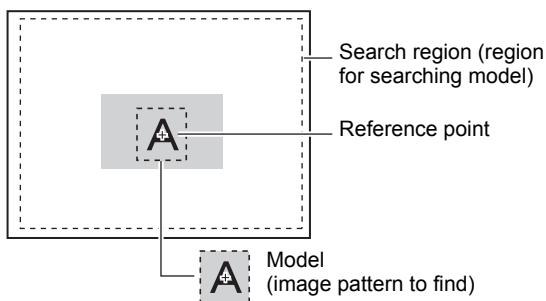

Measurement

Parts resembling the model are searched for.

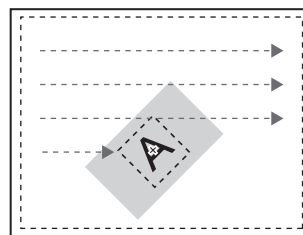

### Region settings

This function sets the region to be registered as the model and the region to search for the model.

#### ► MENU mode - [Setup] - [Item] - [Region]

Item	Description
Register model	This function registers the image pattern to find as the model.  Setting the Region p.194
Reference model	The image that is registered as the model can be referenced.
Search region	Set the region in which to search for the model.
Reference point	Set the coordinates of which part of the model are to be output. The default is the center position of the model.



## Threshold

This function sets the judgment conditions.

### ► MENU mode - [Setup] - [Item] - [Limits]

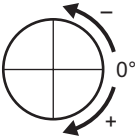
Setup Item	Description
Correlation	Sets the range of the correlation to be judged as OK. Range: 0 to 100
Position XY	Sets the range of movement in the X- and Y- axes of the measurement target to be judged as OK. Range: -9999.999 to 9999.999 (When calibration is OFF, the range of movement for positions X and Y are 0 to 640 and 0 to 480, respectively.)
Angle	Sets the range of rotation angle to be judged as OK. Range: -180 to 180  
Count (enabled only when Verification is set to [ON])	Sets the number of search candidates to be judged as OK. Range: 0 to 99

## Image adjustment (if necessary)

The following items can be changed and set to the image of the measurement target.

### ► MENU mode - [Setup] - [Item] - [Img Adj]

Item	Description
Select camera	 For details, see "Image Adjustment". p.94
Color filter	
Filtering	
BGS* level	

\*BGS: Background Suppression

## Detailed settings (if necessary)

When measurement is not stable, adjust the detailed conditions.

### ► MENU mode - [Setup] - [Item] - [Detail]

Setup Item	Setting value	Description
Search mode	Hi-speed	The search is performed at high speed.
	Normal (default value)	The search is performed in the normal mode for both speed and precision.
	Precision	The position is calculated at high precision in sub-pixel units (units smaller than pixels).
Rotation range	0 to 180° (default value: 0)	Sets in which angle range the model (rotated in degree units) is to be created. The smaller the skipping angle that is set, the higher the precision becomes, however, the longer the processing time becomes.
Skipping angle	1, 2, 3, 5, 10, 15, 20, 30° (default value: 10°)	<b>Important</b> When the rotation range and skipping angle have been changed, register the model again.
Interpolation	OFF (default value)	Calculates the angle in skipping angle units.
	ON	The angle is calculated as a numerical value down to three digits past the decimal point based on the value obtained in skipping angle units. Note, however, that the processing time increases. This function is enabled only when the search mode is the normal mode or the precision mode.
Verification	OFF (default value)	The search is performed in detail near a candidate point having the highest correlation value.
	ON	The search is performed in detail near all candidate points. Select [ON] when the model cannot be searched for stably.
Candidate level	0 to 100 (default value: 60)	Sets the level at which the model is searched for during a rough search. Images having a correlation value at the candidate level or more are taken to the candidate points in the Verification. Set a lower level when the model cannot be searched for stably.
Calibration	OFF (default value)	Measurement results are output using the camera's coordinate values.
	ON	Measurement results are output using the coordinate value converted by the calibration function.
Coordinates mode	Normal (default value)	The position information of the input image coordinate system itself is output.
	Pos. correction	When position shift correction is set, the position information is output using the coordinate system corrected to the original state when the coordinate system was registered.

 Coordinates mode p.74

**Note** Verification and candidate level

A rough search is performed inside the search region to find the candidate point.

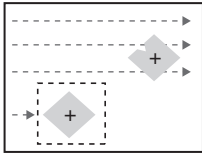

Verification ON

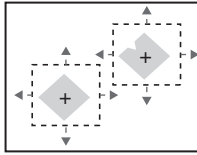

A detailed search is performed at images near all candidate points.



Verification OFF

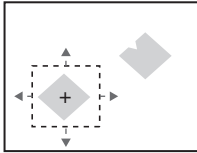

A detailed search is performed at images near the candidate point having the highest correlation.

**Note** Search Rotation Range

Models in the range set by Rotation range are created based on the registered model.

Example: When Rotation range is 15° and Skipping angle is 5°

Registered model

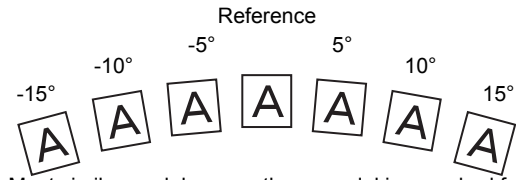

Most similar model among these model is searched for.

## Possible output results

The following values can be output when expressions are set.

Item	Description	Message
Judgment result	The judgment result is output. (0:OK, -1:NG, -2: not measured)	Judge (JG)
Correlation	The degree of match between the measurement image and model image are output as a correlation value. (0 to 100)	Correlation (CR)
Measurement position	The X, Y coordinates of the position where the model was found are output. (-9999.999 to 9999.999)	Position X, Y (X, Y)
Measurement angle	The rotation angle of the model that was found is output. (-180 to 180)	Angle (TH)
Search number	The number of searches that have a correlation value at the correlation lower limit value or above is output. (0 to 99)	Search count (N)
Reference position	The X, Y coordinates when the model was registered are output. (-9999.999 to 9999.999)	Reference X, Y (SX, SY)
Reference angle	The angle when the model was registered is output. (-180 to 180)	Ref. angle (ST)
Position difference	The position difference obtained by "measurement position - reference position" is output. (-9999.999 to 9999.999)	Position dif. X, Y (DX, DY)
Angle difference	The angle difference obtained by "measurement position - reference position" is output. (-180 to 180)	Angle dif. (DT)

### Note

#### Reference position/angle, position difference/angle difference

Reference position = position of model when model is registered

Reference angle = angle of model when model is registered

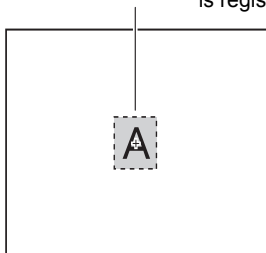

Measurement position = position of model found by measurement

Measurement angle = angle of model found by measurement

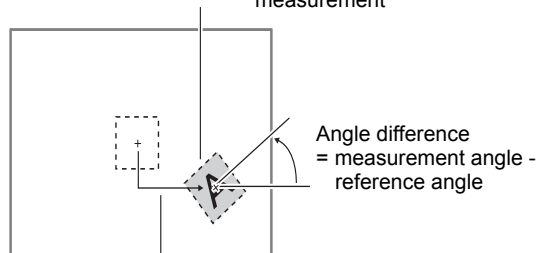

Angle difference = measurement angle - reference angle

Position difference = measurement position - reference position

## Graphic Search

Use this item when it is difficult to search for a model from partially clipped images or low-contrast images. The degree of match indicating how much parts resemble each other and the position of the measurement object can be output.

### Setup

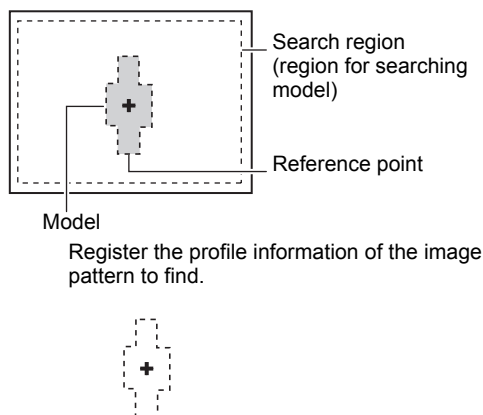

### Measurement

Parts resembling the model are searched for stably even in the following environments.

#### Lots of noise

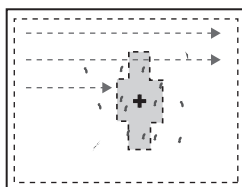

#### Partially clipped

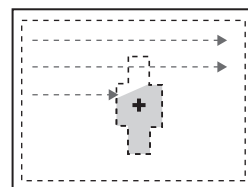

#### Low contrast

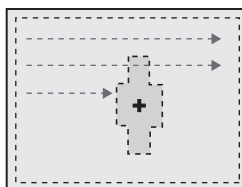

#### Inclined

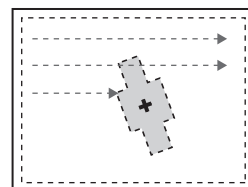

### Note Comparison with Pattern Search

In a pattern search, a model of the image pattern is used with priority given to contrast information. However, in a graphic search, a model with priority given to profile information is used.

## Region settings

This function sets the region to be registered as the model and the region to search for the model.

### ► MENU mode - [Setup] - [Item] - [Region]

Item	Description
Register model	This function registers the image pattern to find as the model.
Reference model	The image that is registered as the model can be referenced.
Search region	Set the region in which to search for the model.
Reference point	Set the coordinates of which part of the model are to be output. The default is the center position of the model.

- 1** Select [Auto] and enclose the area in which the profile is to be traced.
- 2** Select [Auto] displayed on the lower left of the screen for region settings.  
The profile is traced.
- 3** If the profile is partially clipped, trace by [Free], [Box], [Ellipse] or [Line].  
Delete any noise with the [Erase] tool if noise has been traced.

## Threshold

This function sets the judgment conditions.

### ► MENU mode - [Setup] - [Item] - [Limits]

Setup Item	Description
Correlation	Sets the range of the correlation to be judged as OK. Range: 0 to 100
Position XY	Sets the range of movement in the X- and Y-axes of the measurement target to be judged as OK. Range: -9999.999 to 9999.999 (When calibration is OFF, the range of movement for positions X and Y are 0 to 640 and 0 to 480, respectively.)
Angle	Sets the range of rotation angle to be judged as OK. Range: -180 to 180   +/- direction of angle p.47

## Image adjustment (if necessary)

The following items can be changed and set to the image of the measurement target.

### ► MENU mode - [Setup] - [Item] - [Img Adj]

Item	Description
Select camera	 For details, see "Image Adjustment". p.94
Color filter	
Filtering	
BGS* level	

## Detailed settings (if necessary)

When measurement is not stable, adjust the detailed conditions.

### ► MENU mode - [Setup] - [Item] - [Detail]

Setup Item	Setting value	Description
Search mode	Hi-speed	The search is performed at high speed.
	Normal (default value)	The search is performed in the normal mode.
	Precision	The position is calculated at high precision in sub-pixel units (units smaller than pixels).
Rotation range	0 to 180° (default value: 0)	Sets in which angle range the model (rotated in degree units) is to be created. The smaller the skipping angle that is set, the higher the precision becomes, however, the longer the processing time becomes. <b>Important</b> When the rotation range and skipping angle have been changed, register the model again.
Skipping angle	1, 2, 3, 5, 10, 15, 20, 30° (default value: 10°)	
Interpolation	OFF (default value)	Calculates the angle in skipping angle units.
	ON	The angle is calculated as a numerical value down to three digits past the decimal point based on the value obtained in skipping angle units. Note, however, that the processing time increases. This function is enabled only when the search mode is the normal mode or the precision mode.
Candidate level	0 to 100 (default value: 60)	Sets the level at which the model is searched for during a rough search. Images having a value of the degree of match at the candidate level or more are taken to the candidate points in the Verification. Set a lower level when the model cannot be searched for stably.
Calibration	OFF (default value)	Measurement results are output using the camera's coordinate values.
	ON	Measurement results are output using the coordinate value converted by the calibration function.
Coordinates mode	Normal (default value)	The position information of the input image coordinate system itself is output.
	Pos. correction	When position shift correction is set, the position information is output using the coordinate system corrected to the original state when the coordinate system was registered.



- Verification and candidate level p.49
- Search Rotation Range p.49
- Coordinates mode p.74

## Possible output results

The following values can be output when expressions are set.

Item	Description	Message
Judgment result	The judgment result is output. (0:OK, -1:NG, -2: not measured)	Judge (JG)
Correlation	The degree of match between the measurement image and model image are output. (0 to 100)	Correlation (CR)
Measurement position	The X, Y coordinates of the position where the model was found are output. (-9999.999 to 9999.999)	Position X, Y (X, Y)
Measurement angle	The rotation angle of the model that was found is output. (-180 to 180)	Angle (TH)
Search number	The number of searches that have a degree of match at the match lower limit value or above is output. (0 to 99)	Search count (N)
Reference position	The X, Y coordinates when the model was registered are output. (-9999.999 to 9999.999)	Reference X, Y (SX, SY)
Reference angle	The angle when the model was registered is output. (-180 to 180)	Ref. angle (ST)
Position difference	The position difference obtained by "measurement position - reference position" is output. (-9999.999 to 9999.999)	Position dif. X, Y (DX, DY)
Angle difference	The angle difference obtained by "measurement position - reference position" is output. (-180 to 180)	Angle dif. (DT)



Reference position/angle, position difference/angle difference p.50



## Flexible Search

Use this item to detect minute differences to distinguish between passed products and same type. By registering up to 36 image patterns as models beforehand, differences can be absorbed and wasted springs can be prevented.

The correlation indicating how much parts resemble each other and the position of the measurement object can be output.

### Setup

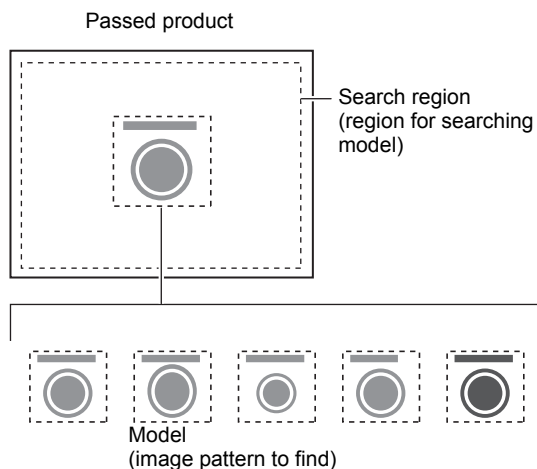

### Measurement

Parts resembling one or some of the multiple registered models are searched for, and the results of the model having the highest degree of match of all of the registered models are acquired.

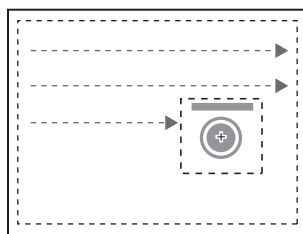

## Region settings

This function sets the region to be registered as the model and the region to search for the model.

### ► MENU mode - [Setup] - [Item] - [Region]

Item	Description
Register model	This function registers the image pattern to find as the model.  Setting the Region p.194
Reference model	The image that is registered as the model can be referenced.
Search region	Set the region in which to search for the model.

## Threshold

This function sets the judgment conditions.

### ► MENU mode - [Setup] - [Item] - [Limits]

Setup Item	Description
Correlation	Sets the range of the correlation to be judged as OK. Range: 0 to 100
Position XY	Sets the range of movement in the X- and Y- axes of the measurement target to be judged as OK. Range: -9999.999 to 9999.999 (When calibration is OFF, the range of movement for positions X and Y are 0 to 640 and 0 to 480, respectively.)

## Image adjustment (if necessary)

The following items can be changed and set to the image of the measurement target.

### ► MENU mode - [Setup] - [Item] - [Img Adj]

Item	Description
Select camera	 For details, see "Image Adjustment". p.94
Color filter	
Filtering	
BGS level	

## Detailed settings (if necessary)

When measurement is not stable, adjust the detailed conditions.

### ► MENU mode - [Setup] - [Item] - [Detail]

Setup Item	Setting value	Description
Search mode	Hi-speed	The search is performed at high speed.
	Normal (default value)	The search is performed in the normal mode for both speed and precision.
	Precision	The position is calculated at high precision in sub-pixel units (units smaller than pixels).
Verification	OFF (default value)	The search is performed in detail near a candidate point having the highest correlation value.
	ON	The search is performed in detail near all candidate points. Select [ON] when the model cannot be searched for stably.
Candidate level	0 to 100 (default value: 60)	Sets the level at which the model is searched for during a rough search. Images having a correlation value at the candidate level or more are taken to the candidate points in the Verification. Set a lower level when the model cannot be searched for stably.
Calibration	OFF (default value)	Measurement results are output using the camera's coordinate values.
	ON	Measurement results are output using the coordinate value converted by the calibration function.
Coordinates mode	Normal (default value)	The position information of the input image coordinate system itself is output.
	Pos. correction	When position shift correction is set, the position information is output using the coordinate system corrected to the original state when the coordinate system was registered.



- Verification and candidate level p.49
- Coordinates mode p.74

## Possible output results

The following values can be output when expressions are set.

Item	Description	Message
Judgment result	The judgment result is output. (0:OK, -1:NG, -2: not measured)	Judge (JG)
Correlation	The degree of match between the measurement image and model image are output as a correlation value. (0 to 100)	Correlation (CR)
Measurement position	The X, Y coordinates of the position where the model was found are output. (-9999.999 to 9999.999)	Position X, Y (X, Y)

## Sensitive Search

Use this item to detect minute differences. Models are automatically subdivided to check the degree of match in detail. The correlation indicating how much parts resemble each other and the position of the measurement target can be output. The correlation and position information of the model having the lowest degree of match of the subdivided models is output.

### Setup

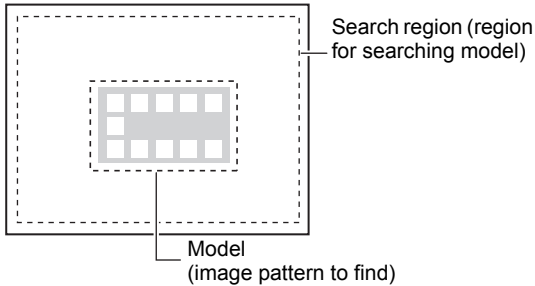

### Measurement

Parts resembling the model are searched, and the degree of match is checked in detail by subdivided models. When subdivided models are a solid color, the solid color rate also can be inspected.

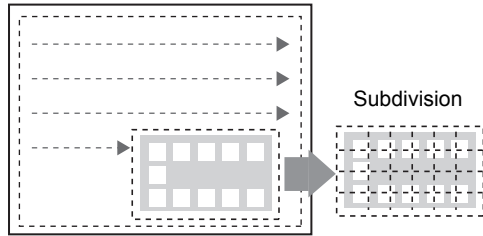

### Note

#### Comparison with pattern search

Example: Passed product

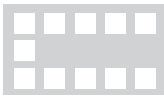

Different type

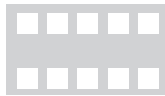

Reversed

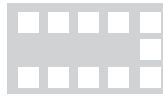

#### < Distribution of Measurement Results >

In a pattern search, a difference in correlation values does not appear, making correlation values difficult to distinguish as there are small differences.

In a Sensitive search, even small differences can be distinguished.

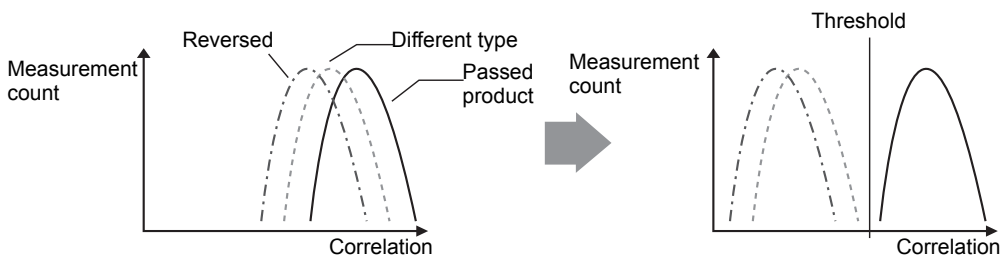

## Region settings

This function sets the region to be registered as the model and the region to search for the model.

### ► MENU mode - [Setup] - [Item] - [Region]

Item	Description
Register model	This function registers the image pattern to find as the model.   Setting the Region p.194
Reference model	The image that is registered as the model can be referenced.
Search region	Sets the region in which to search for the model.

## Threshold

This function sets the judgment conditions.

### ► MENU mode - [Setup] - [Item] - [Limits]

Setup Item	Description
Correlation	Sets the range of the correlation to be judged as OK. Range: 0 to 100
Position XY	Sets the range of movement in the X- and Y- axes of the measurement target to be judged as OK. Range: -9999.999 to 9999.999 (When calibration is OFF, the range of movement for positions X and Y are 0 to 640 and 0 to 480, respectively.)
Solid color rate	Sets the range of solid color to be judged as OK. Range: 0 to 100
Angle	Sets the range of rotation angle to be judged as OK. Range: -180 to 180   +/- direction of angle p.47

## Image adjustment (if necessary)

The following items can be changed and set to the image of the measurement target.

### ► MENU mode - [Setup] - [Item] - [Img Adj]

Item	Description
Select camera	 For details, see "Image Adjustment". p.94
Color filter	
Filtering	
BGS level	

## Detailed settings (if necessary)

When measurement is not stable, adjust the detailed conditions.

### ► MENU mode - [Setup] - [Item] - [Detail]

Setup Item	Setting value	Description
Search mode	Hi-speed	The search is performed at high speed.
	Normal (default value)	The search is performed in the normal mode for both speed and precision.
	Precision	Matching is performed in sub-pixel units. Note, however, that output of position information is in pixel units.
Sensitivity	Low	The model is subdivided into nine models of up to three divisions in each of the horizontal and vertical directions and then measured.
	Middle (default value)	The model is subdivided into 25 models of up to five divisions in each of the horizontal and vertical directions and then measured.
	High	The model is subdivided into 100 models of up to ten divisions in each of the horizontal and vertical directions and then measured.
Rotation range	0 to 180° (default value: 0)	Sets in which angle range the model (rotated in degree units) is to be created. The smaller the skipping angle that is set, the higher the precision becomes, however, the longer the processing time becomes.
Skipping angle	1, 2, 3, 5, 6, 10, 15, 20, 30° (default value: 10°)	
Interpolation	OFF (default value)	Calculates the angle in skipping angle units.
	ON	The angle is calculated as a numerical value down to three digits past the decimal point based on the value obtained in skipping angle units. Note, however, that the processing time increases. This function is enabled only when the search mode is the normal mode or the precision mode.
Verification	OFF (default value)	The search is performed in detail near a candidate point having the highest correlation value.
	ON	The search is performed in detail near all candidate points. Select [ON] when the model cannot be searched for stably.
Candidate level	0 to 100 (default value: 60)	Sets the level at which the model is searched for during a rough search. Images having a correlation value at the candidate level or more are taken to the candidate points in the Verification. Set a lower level when the model cannot be searched for stably.
Solid color check	OFF (default value)	Select [ON] when inspecting sections of solid color on subdivided models.
	ON	
Calibration	OFF (default value)	Measurement results are output using the camera's coordinate values.
	ON	Measurement results are output using the coordinate value converted by the calibration function.
Coordinates mode	Normal (default value)	The position information of the input image coordinate system itself is output.
	Pos. correction	When position shift correction is set, the position information is output using the coordinate system corrected to the original state when the coordinate system was registered.



- Verification and candidate level p.49
- Search Rotation Range p.49
- Coordinates mode p.74

**Note**

The minimum size of subdivided models is 32 x 32 pixels.

**Important**

When the sensitivity, rotation range, and skipping angle have been changed, register the model again.

**Possible output results**

The following values can be output when expressions are set.

Item	Description	Message
Judgment result	The judgment result is output. (0:OK, -1:NG, -2: not measured)	Judge (JG)
Correlation	The degree of match between the measurement image and model image are output as a correlation value. The correlation and position information of the model having the lowest degree of match of the subdivided models is output. (0 to 100)	Correlation (CR)
Measurement position	The X, Y coordinates of the location having the lowest correlation value, as a result of having calculated the correlation value in detail by subdivided models, are output. (-9999.999 to 9999.999)	Position X, Y (X, Y)
Solid color rate	The rate that the model is a solid color is output. The higher the solid color rate, the higher the value increases. (0 to 100)	Solid color rate (SC)
Measurement angle	The rotation angle of the model that was found is output. (-180 to 180)	Angle (TH)

# Size Inspection

## Area

The area, gravity and angle of the desired color can be measured. This allows you to inspect the size of the measurement target, and detect positions and stance.

Setup

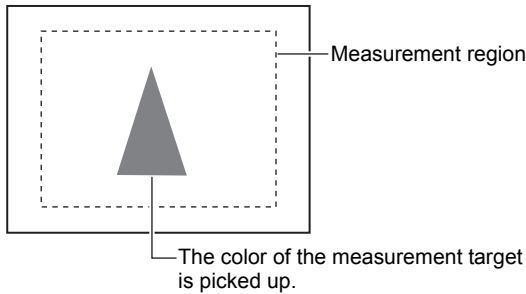

Measurement

Only the picked up color is judged to be the measurement target.

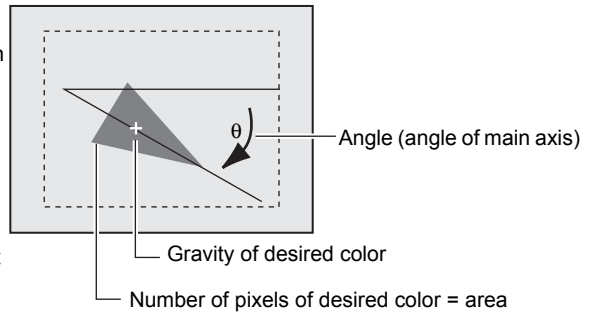

### Note

When a color camera is connected, up to four colors can be specified as the color to be measured.  
 When a monochrome camera is connected to the Controller, black-and-white images are binarized. White pixels are targeted in measurement.

## Image adjustment

This function picks up the color to be measured.

### ► MENU mode - [Setup] - [Item] - [Img Adj]

Item	Description
Select camera	 For details, see "Image Adjustment". p.94 (Filtering and BGS level can be used only when a monochrome camera is connected.)
Color Pickup/Binary	
Filtering	
BGS level	



## Region settings

This function sets the measurement region.

### ► MENU mode - [Setup] - [Item] - [Region]

Item	Description
Measurement region	This function sets the region to be measured.   Setting the Region p.194
Reference registration	When the measurement region is set, measurement is executed on the display image, and the result of execution is registered as the reference value. To re-register only reference values, you can use this function to re-register only reference values based on the image currently on screen.

## Threshold

This function sets the judgment conditions.

### ► MENU mode - [Setup] - [Item] - [Limits]

Setup Item	Description
Area	Sets the range of the area to be judged as OK. Range: 0 to 9999999.999 (When calibration is OFF, the range becomes 0 to 307200.)
Gravity XY	Sets the range of movement in the X- and Y- axes of the measurement target to be judged as OK. Range: -9999.999 to 9999.999 (When calibration is OFF, the range of movement for positions X and Y are 0 to 608 and 0 to 464, respectively.)
Axis angle	Sets the rotating range of the measurement target to be judged as OK. Range: -90.0 to 90.0

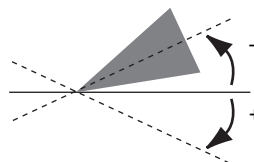

## Detailed settings (if necessary)

When measurement is not stable, adjust the detailed conditions.

### ► MENU mode - [Setup] - [Item] - [Detail]

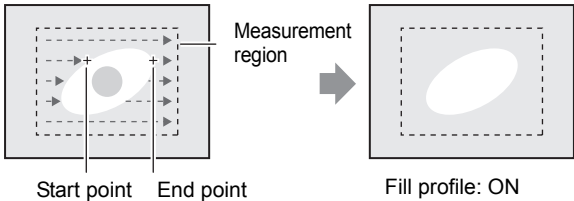
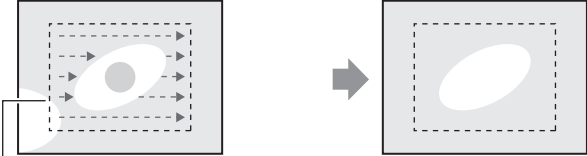
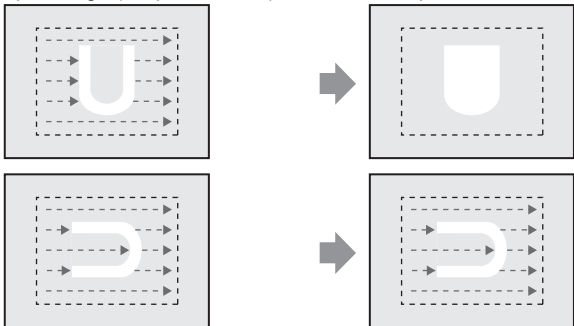
Setup Item	Setting value	Description
Measure axis angle	OFF (default value)	Sets whether or not to measure the axis angle. When [ON] is selected, the processing time increases proportionately to the time it takes to measure the axis angle.
	ON	
Fill profile	OFF (default value)	To measure the outer periphery of the measurement target, set this item to [ON]. When this item is set to [ON], measurement is performed with all of the area between the start point (colors outside of measurement target → measurement target color) and the end point (measurement target color → colors outside of measurement target) inside the measurement region judged to the measurement target color.
	ON	
		 <p>Start point    End point    Measurement region    Fill profile: ON</p> <p><b>When the measurement target color overlaps the measurement region</b></p> <p>Input image (Fill profile: OFF)    Fill profile: ON</p>  <p>Input image (Fill profile: OFF)    Fill profile: ON</p> <p>Pixels that are measurement target color are not recognized as the start point as pixels that are colors outside of measurement target are next scanned.</p> <p><b>When measuring the measurement target with unevenness</b></p> <p>The measurement result changes according to the direction in which the measurement target is fed.</p> <p>Input image (Fill profile: OFF)    Fill profile: ON</p>  <p>Input image (Fill profile: OFF)    Fill profile: ON</p>
Calibration	OFF (default value)	Measurement results are output using the camera's coordinate values.
	ON	Measurement results are output using the coordinate value converted by the calibration function.
Coordinates mode	Normal (default value)	The position information of the input image coordinate system itself is output.
	Pos. correction	When position shift correction is set, the position information is output using the coordinate system corrected to the original state when the coordinate system was registered.

 Coordinates mode p.74

## Possible output results

The following values can be output when expressions are set.

Item	Description	Message
Judgment result	The judgment result is output. (0:OK, -1:NG, -2: not measured)	Judge (JG)
Area	The area of the measurement target color is output. (0 to 9999999.999)	Area (AR)
Gravity position	The X, Y coordinates of the gravity of the measurement target color are output. (-9999.999 to 9999.999)	Gravity X, Y (X, Y)
Axis angle	The angle of the measurement target color is output. (-90.0 to 90.0)	Axis angle (TH)
Reference area	The area when the measurement region is set is output. (0 to 9999999.999)	Ref. area (SA)
Reference position	The X, Y coordinates of the gravity when the measurement region is set are output. (-9999.999 to 9999.999)	Reference X, Y (SX, SY)
Reference axis angle	The angle when the measurement region is set is output. (-90.0 to 90.0)	Ref. axis angle (ST)
Area difference	The area difference obtained by "measurement value - reference value" is output. (-9999999.999 to 9999999.999)	Area dif. (DA)
Position difference	The position difference obtained by "gravity position - reference position" is output. (-9999.999 to 9999.999)	Position dif. X, Y (DX, DY)
Axis angle difference	The axis angle difference obtained by "measurement value - reference value" is output. (-180.0 to 180.0)	Axis angle dif. (DT)

 Reference position and Position difference p.50

## Labeling

A group of colors to be measured is counted as a "label." Label Nos. are assigned to each label after being arranged in order of position and size. The total number of labels and the size/position of any label can be output.

### Setup

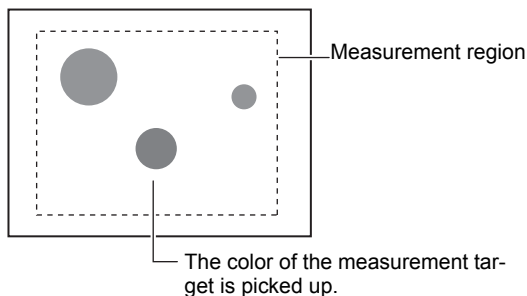

### Measurement

A group of picked up colors is detected as a label.

Number of picked up labels: 3

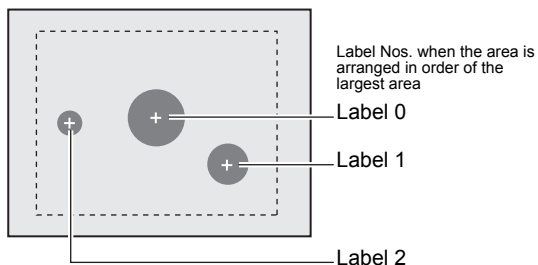

### Note

When a color camera is connected, up to four colors can be specified as the color to be measured. When a monochrome camera is connected to the Controller, black-and-white images are binarized. White pixels are targeted in measurement.

## Image adjustment

This function picks up the color to be measured.

### ► MENU mode - [Setup] - [Item] - [Img Adj]

Item	Description
Select camera	 For details, see "Image Adjustment". p.94 (Filtering and BGS level can be used only when a monochrome camera is connected.)
Color Pickup/Binary	
Filtering	
BGS level	

## Region settings

This function sets the measurement region.

### ► MENU mode - [Setup] - [Item] - [Region]

Item	Description
Measurement region	This function sets the region to be measured.   Setting the Region p.194
Reference registration	When the measurement region is set, measurement is executed on the display image, and the result of execution is registered as the reference value. To re-register only reference values, you can use this function to re-register only reference values based on the image currently on screen.

## Threshold

This function sets the judgment conditions.

Judgment is performed on corresponding label Nos.

### ► MENU mode - [Setup] - [Item] - [Limits]

Setup Item	Description
Area	Sets the range of the area to be judged as OK. Range: 0 to 9999999.999 (When calibration is OFF, the range of the area becomes 0 to 307200.)
Gravity XY	Sets the range of movement in the X- and Y-axes of the measurement target to be judged as OK. Range: -9999.999 to 9999.999 (When calibration is OFF, the range of movement for positions X and Y are 0 to 640 and 0 to 480, respectively.)
Number of labels	Sets the number of labels of the measurement target to be judged as OK. Range: 0 to 65535
Axis angle	Sets the rotating range of the measurement target to be judged as OK. Range: -90.0 to 90.0   +/- direction of angle p.63
Perimeter	Sets the perimeter of the measurement target to be judged as OK. Range: 0 to 9999999.999 (When calibration is OFF, the range of the perimeter becomes 0 to 200000.)
Length XY	Sets the X and Y lengths of the box circumscribing the measurement target to be judged as OK. Range: -9999.999 to 9999.999 (When calibration is OFF, the range of movement for positions X and Y are 0 to 640 and 0 to 480, respectively.)
Roundness	Sets the roundness of the measurement target to be judged as OK. Range: 0 to 1.0

## Detailed settings (if necessary)

When measurement is not stable, adjust the detailed conditions.

### ► MENU mode - [Setup] - [Item] - [Detail]

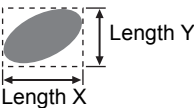
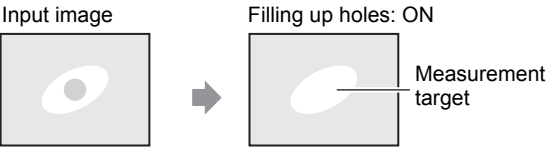
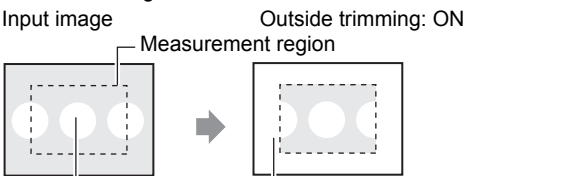
Setup Item	Setting value	Description
Labeling mode	Precision	The image is measured without being compressed.
	Normal (default value)	The image is measured at high speed after being compressed to 1/2 size in both the horizontal and vertical directions.
Sort mode	Area descending order (default value)	Re-assigns label Nos. in order of the largest area.
	Area ascending order	Re-assigns label Nos. in order of the smallest area.
	X gravity descending order	Re-assigns label Nos. in order of the largest X gravity coordinate.
	X gravity ascending order	Re-assigns label Nos. in order of the smallest X gravity coordinate.
	Y gravity descending order	Re-assigns label Nos. in order of the largest Y gravity coordinate.
	Y gravity ascending order	Re-assigns label Nos. in order of the smallest Y gravity coordinate.
Label No.	0 to 2499 (default value: 0)	Sets the label No. whose data is to be output. Note, however, that the label count that can be measured differs according to the Controller model.
Measure axis angle	OFF (default value)	When set to "ON", the axis angle is calculated.
	ON	
Measure perimeter	OFF (default value)	When "ON", the following parameters are calculated:  <ul style="list-style-type: none"> <li>•Length X</li> <li>•Length Y</li> <li>•Perimeter</li> </ul>
	ON	
Measure roundness	OFF (default value)	Sets whether or not to calculate roundness. Roundness = $(4\pi \times \text{area}) / (\text{perimeter} \times \text{perimeter})$
	ON	
Filling up holes	OFF (default value)	Selects how to process parts other than the target color that are enclosed by the target color to be measured, such as a doughnut. When "ON" is set, parts are processed as the target color to be measured. 
	ON	
Outside trimming	OFF (default value)	Set this function when the measurement region contains colors other than the measurement color that are not required in measurement. When "ON" is set, the entire region outside of the measurement region is measured as the color to be measured. 
	ON	

Setup Item	Setting value	Description
Area judgment	0 to 9999999.999 (default value: 0)	Sets the minimum area value to be counted as a label. Set a larger value when noise is counted as a label by mistake.
Calibration	OFF (default value)	Measurement results are output using the camera's coordinate values.
	ON	Measurement results are output using the coordinate value converted by the calibration function.
Coordinates mode	Normal (default value)	The position information of the input image coordinate system itself is output.
	Pos. correction	When position shift correction is set, the position information is output using the coordinate system corrected to the original state when the coordinate system was registered.

 Coordinates mode p.74

## Possible output results

The following values can be output when expressions are set.

Item	Description	Message
Judgment result	The judgment result is output. (0: OK, -1: NG, -2: not measured)	Judge (JG)
Area	The area of the corresponding label is output. (0 to 9999999.999)	Area (AR)
Gravity position	The X, Y coordinates of the gravity of the corresponding label are output. (-9999.999 to 9999.999)	Gravity X, Y (X, Y)
Number of labels	The total number of labels is output. (0 to 65535)	Number of labels (N)
Axis angle	The angle of the corresponding label is output. (-90.0 to 90.0)	Axis angle (TH)
Perimeter	The perimeter of the corresponding label is output. (0 to 9999999.999)	Perimeter (L)
Length XY	The X and Y lengths of the box circumscribing the corresponding label are output. (0 to 9999.999)	Length X, Y (LX, LY)
Roundness	The roundness of the corresponding label is output. (0 to 1.0)	Roundness (CL)
Reference area	The area of the corresponding label when the measurement region is set is output. (0 to 9999999.999)	Ref. area (SA)
Reference position	The X, Y coordinates of the gravity of the corresponding label when the measurement region is set are output. (-9999.999 to 9999.999)	Reference X, Y (SX, SY)
Reference axis angle	The angle of the corresponding label when the measurement region is set are output. (-90.0 to 90.0)	Ref. axis angle (ST)
Reference perimeter	The perimeter of the corresponding label when the measurement region is set is output. (0 to 9999999.999)	Ref. perimeter (SL)
Reference length XY	The X and Y lengths of the box circumscribing the corresponding label when the measurement region is set are output. (0 to 9999.999)	Ref. length X, Y (SLX, SLY)
Reference roundness	The roundness of the corresponding label when the measurement region is set is output. (0 to 1.0)	Ref. roundness (SC)
Area difference	The area difference obtained by "measurement value - reference value" is output. (-9999999.999 to 9999999.999)	Diff. area (DA)
Position difference	The position difference obtained by "gravity position - reference position" is output. (-9999.999 to 9999.999)	Displacement X, Y (DX, DY)
Axis angle difference	The axis angle difference obtained by "measurement value - reference value" is output. (-180.0 to 180.0)	Diff. axis angle (DT)
Perimeter difference	The perimeter difference obtained by "measurement value - reference value" is output. (-9999999.999 to 9999999.999)	Diff. perimeter (DL)
Length XY difference	The length difference obtained by "measurement value - reference value" is output. (-9999.999 to 9999.999)	Diff. length X, Y (DLX, DLY)
Roundness difference	The roundness difference obtained by "measurement value - reference value" is output. (-1.0 to 1.0)	Diff. roundness (DC)

 Reference position and position difference p.50

# Edge Inspection

## Position

This item uses the changes in brightness in a region to detect edge(s). Use this item to calculate the coordinates of the edge(s) of a measurement target.

### Setup

To acquire the X coordinate of the edge

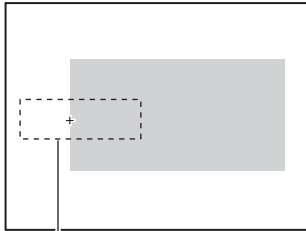

Measurement region  
Change in color: light → dark

### Measurement

The edge is searched in the region according to the preset direction and change in color.

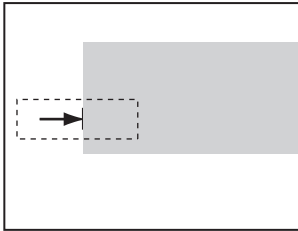

## Region settings

This function sets the measurement region.

### ► MENU mode - [Setup] - [Item] - [Region]

Item	Description
Measurement region	This function sets the region to be measured.  Setting the Region p.194
Reference registration	When the measurement region is set, measurement is executed on the display image, and the result of execution is registered as the reference value. To re-register only reference values, you can use this function to re-register only reference values based on the image currently on screen.

#### Note

#### Edge search direction

The edge is searched from the start point towards the end point of the region.

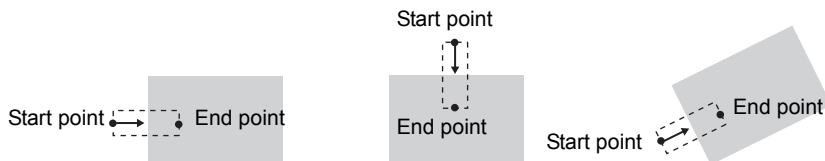



## Threshold

This function sets the judgment conditions.

### ▶ MENU mode - [Setup] - [Item] - [Limits]

Setup Item	Description
Position XY	Sets the range of movement in the X- and Y- axes of the measurement target to be judged as OK. Range: -9999.999 to 9999.999 (When calibration is OFF, the range of movement for positions X and Y are 0 to 640 and 0 to 480, respectively.)

## Image adjustment (if necessary)

The following items can be changed and set to the image of the measurement target.

### ▶ MENU mode - [Setup] - [Item] - [Img Adj]

Item	Description	
Select camera	 For details, see "Image Adjustment". p.94	
Color filter		
Color Pickup/Binary		Which of Color filter or Color Pickup is used can be selected at [Detail] - [Color mode]. The default is use of Color filter.
Filtering		
BGS level		

## Detailed settings (if necessary)

When measurement is not stable, adjust the detailed conditions. By the automatic setting, the edge search color is automatically set.

### ► MENU mode - [Setup] - [Item] - [Detail]

Setup Item	Setting value	Description
Measurement mode	Average (default value)	Sets the method for calculating the position of the edge(s).
	Peak	
	Bottom	
Color mode	Filter mode (default value)	Color filter processing improves the contrast of images so that edges are detected.
	Pickup mode	Specify the color to measure to find the edge of that color.
Split size	1 to 99 (default value: 1)	Sets the calculation width when the peak/bottom positions are to be calculated. The peak or bottom is calculated after the measurement region is split up by the calculation width to find the edge(s).
Color	Light → Dark (default value)	Selects the density change direction of the edge(s) to be detected.
	Dark → Light	
Edge level	0 to 100 (default value: 50)	Sets the level of density change to be judged as an edge.
Noise level	0 to 255 (default value: 20)	Sets the level to be judged as noise. When the difference between the minimum and maximum density values in the density region is at the noise level or lower, it is judged that there are no edges. Set a higher value when noise causes an edge to be detected by mistake.
Noise width	0 to 255 (default value: 0)	Sets the width to be judged as noise. Set a higher value when noise causes an edge to be detected by mistake.
Calibration	OFF (default value)	Measurement results are output using the camera's coordinate values.
	ON	Measurement results are output using the coordinate value converted by the calibration function.
Coordinates mode	Normal (default value)	The position information of the input image coordinate system itself is output.
	Pos. correction	When position shift correction is set, the position information is output using the coordinate system corrected to the original state when the coordinate system was registered.

**Note**

**Measurement mode**

Sets the method for calculating the position of the edge(s).  
 The side far from the start point of the measurement region is the peak, and the side near the start point is the bottom.

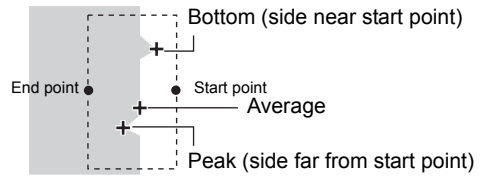

**Split size**

The inside of the measurement region is divided into smaller areas to search for the edge(s), and the peak/bottom/average are calculated. This calculated width is then set.

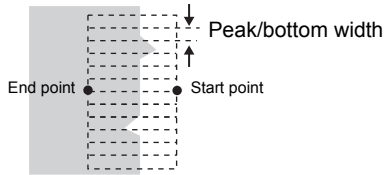

**Edge level**

Edges are detected as follows:

1. The density distribution of the entire measurement region is calculated.
2. The maximum value is taken to 100% from the minimum density value.
3. Places where the density of the edge level changes are detected as edges.

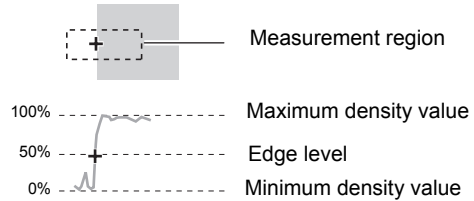

**Noise level**

The minimum and maximum density values in the edge detection region are calculated, and it is judged that there are no edges when the difference between these values is at the noise level or lower. Normally, this setting may be left at its default value of 20. However, set a higher value when noise causes an edge to be detected by mistake. (in region)

Maximum density value - minimum density value < noise level → Judged as "no edge" → Measurement result NG

Maximum density value - minimum density value ≥ Noise level → Judged as "edge" → Taken to be measurement target

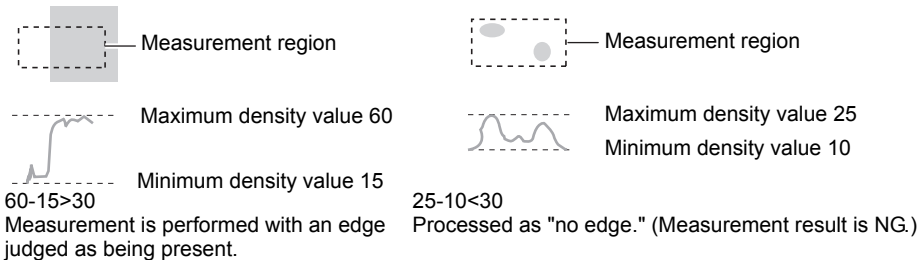

**Noise width**

When the density distribution reaches or falls below the edge level again within the range of the noise width from the initial edge detection position, the detected point is regarded as noise. Normally, this setting may be left at its default value of 0. However, set a higher value when noise causes an edge to be detected by mistake.

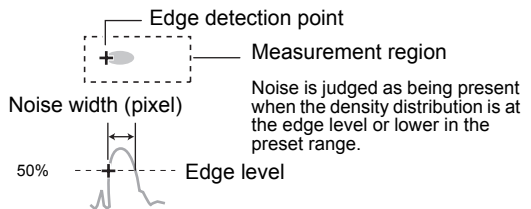

**Note****Coordinates mode**

Sets correction of the output coordinate system at output of the position information to ON/OFF.

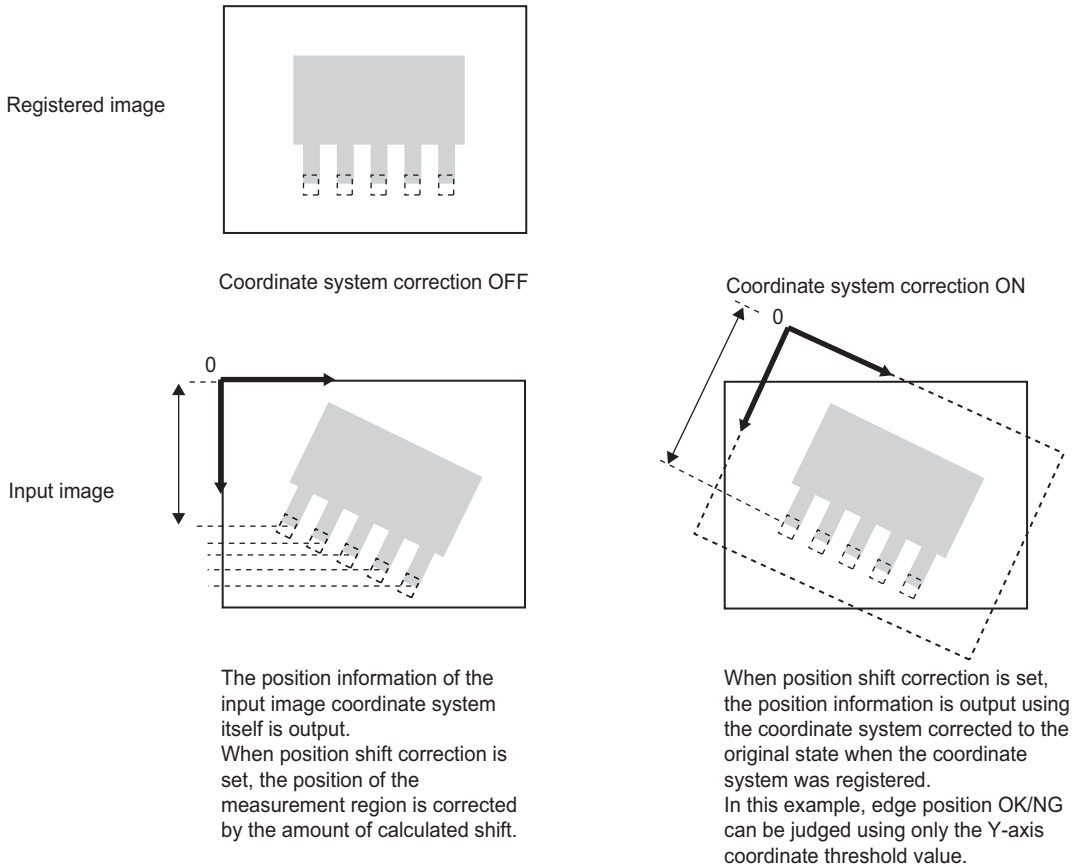
**Possible output results**

The following values can be output when expressions are set.

Item	Description	Message
Judgment result	The judgment result is output. (0:OK, -1:NG, -2: not measured)	Judge (JG)
Edge position	The X, Y coordinates of the edge position are output. (-9999.999 to 9999.999)	Position X, Y (X, Y)
Reference position	The X, Y coordinates of the edge position when the measurement region is set are output. (-9999.999 to 9999.999)	Reference X, Y (SX, SY)
Position difference	The difference obtained by "measurement position - reference position" is output. (-9999.999 to 9999.999)	Position dif. X, Y (DX, DY)

For details on reference position, position difference p.50

## Width

This item uses the changes in brightness in a region to detect edge(s). Two edges are found in a single measurement region, and the distance between these edges is output as a dimension.

### Setup

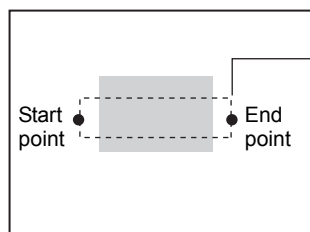

Measurement region

### Measurement

Two edges are searched in the region.

Edge 1 is searched from the start point towards the end point. Edge 2 is searched from the end point towards the start point.

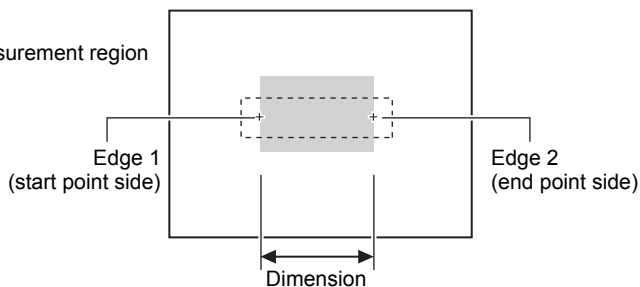

## Region settings

This function sets the measurement region.

### ► MENU mode - [Setup] - [Item] - [Region]

Item	Description
Measurement region	This function sets the region to be measured.   Setting the Region p.194
Reference registration	When the measurement region is set, measurement is executed on the display image, and the result of execution is registered as the reference value. To re-register only reference values, you can use this function to re-register only reference values based on the image currently on screen.

## Threshold

This function sets the judgment conditions.

### ► MENU mode - [Setup] - [Item] - [Limits]

Setup Item	Description
Width	Sets the range of the edge width to be judged as OK. Range: 0 to 9999.999 (When calibration is OFF, the range becomes 0 to 800.)
Position X1, Y1 Position X2, Y2	Sets the range of movement in the X- and Y- axes to be judged as OK. Range: -9999.999 to 9999.999 (When calibration is OFF, the range of movement for positions X and Y are 0 to 640 and 0 to 480, respectively.)

## Image adjustment (if necessary)

The following items can be changed and set to the image of the measurement target.

### ► MENU mode - [Setup] - [Item] - [Img Adj]

Item	Description
Select camera	 For details, see "Image Adjustment". p.94 Which of Color filter or Color Pickup is used can be selected at [Detail] - [Color mode]. The default is use of Color filter.
Color filter	
Color Pickup/Binary	
Filtering	
BGS level	

## Detailed settings (if necessary)

When measurement is not stable, adjust the detailed conditions. By the automatic setting, the edge search color is automatically set.

### ► MENU mode - [Setup] - [Item] - [Detail]

Setup Item	Setting value	Description
Measurement mode	Average (default value)	Sets the method for calculating the edge width.
	Maximum	
	Minimum	
Color mode	Filter mode (default value)	Color filter processing improves the contrast of images so that edges are detected.
	Pickup mode	Specify the color to measure to find the edge of that color.
Split size	1 to 99 (default value: 1)	Sets the calculation width when the Maximum/Minimum widths are to be calculated. The Maximum or Minimum is calculated after the measurement region is split up by the calculation width to find the edge(s).
Color 1/2	Light → Dark (default value)	Selects the density change direction of the edge(s) to be detected.
	Dark → Light	
Edge level 1/2	0 to 100 (default value: 50)	Sets the level of density change to be judged as an edge.
Noise level 1/2	0 to 255 (default value: 20)	Sets the level to be judged as noise. When the difference between the minimum and maximum density values in the density region is at the noise level or lower, it is judged that there are no edges. Set a higher value when noise causes an edge to be detected by mistake.
Noise width 1/2	0 to 255 (default value: 0)	Sets the width to be judged as noise. Set a higher value when noise causes an edge to be detected by mistake.
Calibration	OFF (default value)	Measurement results are output using the camera's coordinate values.
	ON	Measurement results are output using the coordinate value converted by the calibration function.

Setup Item	Setting value	Description
Coordinates mode	Normal (default value)	The position information of the input image coordinate system itself is output.
	Pos. correction	When position shift correction is set, the position information is output using the coordinate system corrected to the original state when the coordinate system was registered.

- Split size, Edge level, Noise level, Noise width p.73
- Coordinates mode p.74

**Note**

**Measurement mode**

When Maximum and Minimum are selected, the measurement region is split up into small regions by Split size to calculate the edge width. The maximum value or the minimum value is output. When Average is selected, the average of the entire measurement region is calculated.

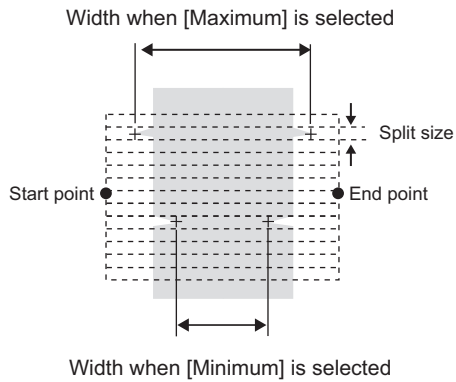

## Possible output results

The following values can be output when expressions are set.

Item	Description	Message
Judgment result	The judgment result is output. (0:OK, -1:NG, -2: not measured)	Judge (JG)
Edge width	The measured edge width is output. (0 to 9999.999)	Width (WD)
Edge position 1/2	The X, Y coordinates of the edge position are output. (-9999.999 to 9999.999)  <div style="border: 1px solid black; padding: 2px; display: inline-block; margin: 5px 0;"><b>Important</b></div> The start point side of the region becomes Position X1/Y1, and the end point side becomes Position X2/Y2.	Position X1, Y1, X2, Y2 (X1, Y1, X2, Y2)
Reference edge width	The edge width when the measurement region is set is output. (0 to 9999.999)	Reference width (SW)
Reference edge position 1/2	The X, Y coordinates of the edge position when the measurement region is set are output. (-9999.999 to 9999.999)	Reference X1, Y1, X2, Y2 (SX1, SY1, SX2, SY2)
Width difference	The width difference obtained by "measurement value - reference value" is output. (-9999.999 to 9999.999)	Width dif. (DW)
Position difference 1/2	The difference obtained by "measurement position - reference position" is output. (-9999.999 to 9999.999)	Position dif. X1, Y1, X2, Y2 (DX1, DY1, DX2, DY2)



Position Difference p.50



## Count

This item uses the changes in brightness in a region to detect edge(s). This item finds the edges of a specified color (dark/light) in a single measurement region, and outputs the number, width and pitch of the edges.

Setup

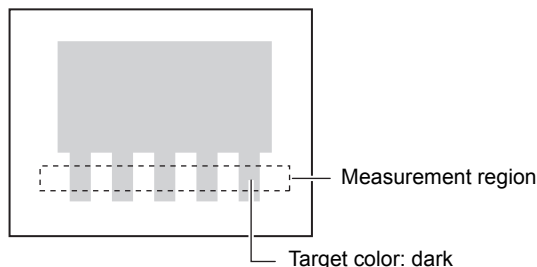

Measurement

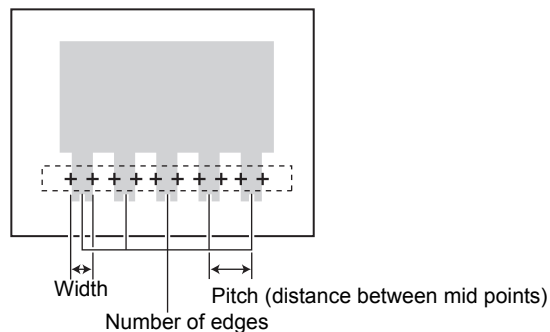

## Region settings

This function sets the measurement region.

### ► MENU mode - [Setup] - [Item] - [Region]

Item	Description
Measurement region	This function sets the region to be measured.   Setting the Region p.194
Reference registration	When the measurement region is set, measurement is executed on the display image, and the result of execution is registered as the reference value. To re-register only reference values, you can use this function to re-register only reference values based on the image currently on screen.

## Threshold

This function sets the judgment conditions.

### ► MENU mode - [Setup] - [Item] - [Limits]

Setup Item	Description
Number of edges	Sets the range of the number of edges to be judged as OK. Range: 0 to 255
Average pitch	Sets the range of the edge pitch to be judged as OK. Range: 0 to 9999.999 (When calibration is OFF, the range becomes 0 to 640.)
Average width	Sets the range of the edge width to be judged as OK. Range: 0 to 9999.999 (When calibration is OFF, the range becomes 0 to 640.)

## Image adjustment (if necessary)

The following items can be changed and set to the image of the measurement target.

### ► MENU mode - [Setup] - [Item] - [Img Adj]

Item	Description
Select camera	 For details, see "Image Adjustment". p.94 Which of Color filter or Color Pickup is used can be selected at [Detail] - [Color mode]. The default is use of Color filter.
Color filter	
Color Pickup/Binary	
Filtering	
BGS level	

## Detailed settings (if necessary)

When measurement is not stable, adjust the detailed conditions.

### ► MENU mode - [Setup] - [Item] - [Detail]

Setup Item	Setting value	Description
Measurement mode	Normal (default value)	Selects this item in the case of measurement targets whose pin width and pitch are at least two pixels.
	Fine	Selects this item to stably measure widths narrower than normal and the number of gaps.
Color mode	Filter mode (default value)	Color filter processing improves the contrast of images so that edges are detected.
	Pickup mode	Specify the color to measure to find the edge of that color.
Target color	Light (default value)	Selects the target color to be counted as the number of edges. When a color camera is in use, the picked-up color is targeted for counting when this setting is set to [Light].
	Dark	
Edge level	0 to 100 (default value: 50)	Sets the level of density change to be judged as an edge.
Noise level	0 to 255 (default value: 20)	Sets the level to be judged as noise. When the difference between the minimum and maximum density values in the density region is at the noise level or lower, it is judged that there are no edges. Set a higher value when noise causes an edge to be detected by mistake.
Noise width	0 to 255 (default value: 0)	Sets the width to be judged as noise. Set a higher value when noise causes an edge to be detected by mistake.
Calibration	OFF (default value)	Measurement results are output using the camera's coordinate values.
	ON	Measurement results are output using the coordinate value converted by the calibration function.

 Noise level, Noise width p.73

**Note****Edge level**

With the count function, the edge is detected by derivative distribution.

1. The amount of change in directions light→dark and dark→light is calculated.
2. The place where the amount of change exceeds the edge level is detected as the edge.

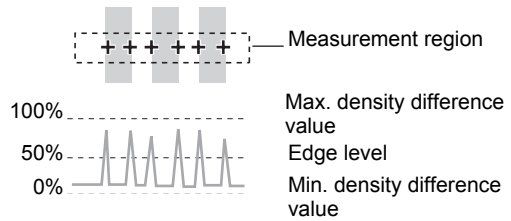
**Possible output results**

The following values can be output when expressions are set.

Item	Description	Message
Judgment result	The judgment result is output. (0:OK, -1:NG, -2: not measured)	Judge (JG)
Number of edges	The number of detected edges is output. (0 to 255)	Number of edges (N)
Average pitch	The average detected pitch is output. (0 to 9999.999)	Average pitch (P)
Minimum pitch	The minimum detected pitch is output. (0 to 9999.999)	Min. pitch (PL)
Maximum pitch	The maximum detected pitch is output. (0 to 9999.999)	Max. pitch (PH)
Average width	The average detected edge width is output. (0 to 9999.999)	Average width (W)
Minimum width	The minimum detected edge width is output. (0 to 9999.999)	Min. width (WL)
Maximum width	The maximum detected edge width is output. (0 to 9999.999)	Max. width (WH)

# Bright/Color Inspection

## Bright

Use this item to measure the brightness of measurement targets. The density average and density deviation (brightness fluctuations) are output. Change in brightness can be used to inspect whether or not parts are present.

Setup

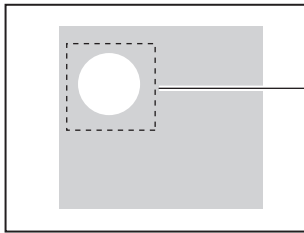

Measurement region

Measurement

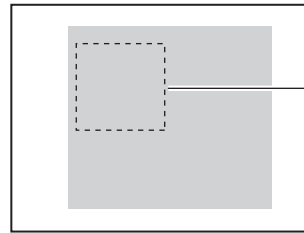

Density average,  
density deviation

## Region settings

This function sets the measurement region.

### ► MENU mode - [Setup] - [Item] - [Region]

Setup Item	Description
Measurement region	This function sets the region to be measured.   Setting the Region p.194
Reference registration	When the measurement region is set, measurement is executed on the display image, and the result of execution is registered as the reference value. To re-register only reference values, you can use this function to re-register only reference values based on the image currently on screen.

## Threshold

This function sets the judgment conditions.

### ► MENU mode - [Setup] - [Item] - [Limits]

Setup Item	Description
Density average	Sets the range of the density average to be judged as OK. Range: 0 to 255.0
Density deviation	Sets the range of the density deviation to be judged as OK. Range: 0 to 127.0

## Image adjustment (if necessary)

The following items can be changed and set to the image of the measurement target.

### ► MENU mode - [Setup] - [Item] - [Img Adj]

Item	Description
Select camera	 For details, see "Image Adjustment". p.94
Color filter	
Filtering	
BGS level	

## Possible output results

The following values can be output when expressions are set.

Item	Description	Message
Judgment result	The judgment result is output. (0:OK, -1:NG, -2: not measured)	Judge (JG)
Density average	The average of the density inside the measurement region is output. (0 to 255.0)	Density average (AV)
Density deviation	The brightness fluctuations in the measurement region are output. (0 to 127.0)	Density deviation (DV)
Reference density average	The density average when the measurement region is set is output. (0 to 255.0)	Ref. average (SA)
Reference density deviation	The density deviation when the measurement region is set is output. (0 to 127.0)	Ref. deviation (SD)
Density average difference	The difference obtained by "measurement value - reference value" is output. (0 to 255.0)	Average dif. (DA)
Density deviation difference	The difference obtained by "measurement value - reference value" is output. (0 to 127.0)	Deviation dif. (DD)

## HUE

Use this item to measure the color of measurement targets. This item can be used to measure whether or not different-colored products are mixed in, for example. Average hue, saturation and brightness value, and respective deviations (fluctuations) can be output.

### Important

This function cannot be used when a monochrome camera is connected.

Setup

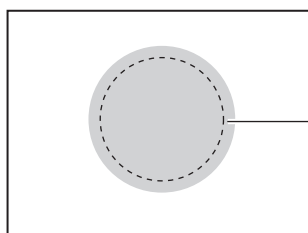

Measurement region

Measurement

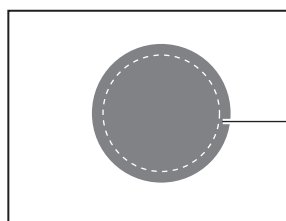

Hue, saturation,  
brightness value

## Region settings

This function sets the measurement region.

### ► MENU mode - [Setup] - [Item] - [Region]

Setup Item	Description
Measurement region	This function sets the region to be measured.   Setting the Region p.194
Reference registration	When the measurement region is set, measurement is executed on the display image, and the result of execution is registered as the reference value. To re-register only reference values, you can use this function to re-register only reference values based on the image currently on screen.

## Threshold

This function sets the judgment conditions.

### Note

- The color can be distinguished more precisely as threshold values can be set to each of hue, saturation and value. Alternatively, if you set wide allowable saturation and value ranges, color can be distinguished more stably by hue without being influenced by fluctuating lighting conditions.

### ► MENU mode - [Setup] - [Item] - [Limits]

Setup Item	Description
Hue average	Sets the range of hues to be judged as OK. Range: 0 to 360.0
Saturation average	Sets the range of saturations to be judged as OK. Range: 0 to 100.0
Value average	Sets the range of values to be judged as OK. Range: 0 to 100.0
Hue deviation	Sets the range of hue fluctuation to be judged as OK. Range: 0 to 180.0
Saturation deviation	Sets the range of saturation fluctuation to be judged as OK. Range: 0 to 50.0
Value deviation	Sets the range of value fluctuation to be judged as OK. Range: 0 to 50.0

## Image adjustment (if necessary)

The following items can be changed and set to the image of the measurement target.

### ► MENU mode - [Setup] - [Item] - [Img Adj]

Item	Description
Select camera	Selects the camera to be used by this item.

## Detailed settings (if necessary)

When measurement is not stable, adjust the detailed conditions.

### ► MENU mode - [Setup] - [Item] - [Detail]

Setup Item	Setting value	Description
Deviation	OFF	Selects whether or not the deviation values of hue, saturation and value are to be calculated.
	ON (default value)	

## Possible output results

The following values can be output when expressions are set.

Item	Description	Message
Judgment result	The judgment result is output. (0:OK, -1:NG, -2: not measured)	Judge (JG)
Hue	The hue average is output. (0 to 360.0)	H average (H)
Saturation	The saturation average is output. (0 to 100.0)	S average (S)
Value	The value average is output. (0 to 100.0)	V average (V)
Hue deviation	The hue fluctuation is output. (0 to 180.0)	H deviation (HD)
Saturation deviation	The saturation fluctuation is output. (0 to 50.0)	S deviation (SD)
Value deviation	The value fluctuation is output. (0 to 50.0)	V deviation (VD)
Reference hue	The hue when the measurement region is set is output. (0 to 360.0)	Ref. H average (SH)
Reference saturation	The saturation when the measurement region is set is output. (0 to 100.0)	Ref. S average (SS)
Reference value	The value when the measurement region is set is output. (0 to 100.0)	Ref. V average (SV)
Hue difference	The hue difference obtained by "measurement value - reference value" is output. (-360.0 to 360.0)	H average dif. (DH)
Saturation difference	The saturation difference obtained by "measurement value - reference value" is output. (-100.0 to 100.0)	S average dif. (DS)
Value difference	The value difference obtained by "measurement value - reference value" is output. (-100.0 to 100.0)	V average dif. (DV)
Reference hue deviation	The hue fluctuation when the measurement region is set is output. (0 to 180.0)	Ref. H deviation (SHD)
Reference saturation deviation	The saturation fluctuation when the measurement region is set is output. (0 to 50.0)	Ref. S deviation (SSD)
Reference value deviation	The value fluctuation when the measurement region is set is output. (0 to 50.0)	Ref. V deviation (SVD)
Hue deviation difference	The hue deviation difference obtained by "measurement value - reference value" is output. (-180.0 to 180.0)	H deviation dif. (DH)
Saturation deviation difference	The saturation deviation difference obtained by "measurement value - reference value" is output. (-50.0 to 50.0)	S deviation dif. (DSD)
Value deviation difference	The value deviation difference obtained by "measurement value - reference value" is output. (-50.0 to 50.0)	V deviation dif. (DVD)
Hue maximum/minimum	The hue maximum/minimum values are output. (0 to 360.0)	Max. H/Min. H (HH, LH)
Saturation maximum/minimum	The saturation maximum/minimum values are output. (0 to 100.0)	Max. S/Min. S (HS, LS)
Value maximum/minimum	The value maximum/minimum values are output. (0 to 100.0)	Max. V/Min. V (HV, LV)

 Nos. indicating hue, saturation and value p.206



# Inspection by Individual Application

## Grouping

Use this item to group products, for example, on lines where many types of products are conveyed. Register the image pattern to be used as the reference for grouping products as a model beforehand. Up to 64 models can be registered. The No. of the model that resembles the input image the most, the correlation indicating how much parts resemble each other and the position of the measurement object can be output.

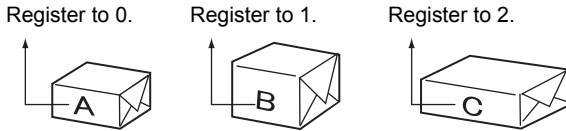

### Setup

Index (0 to 63)	Model (register up to 4)
0	A A A A
1	B B B B
2	C C
⋮	
63	Q Q

### Measurement

The index No. of the most similar model is output.

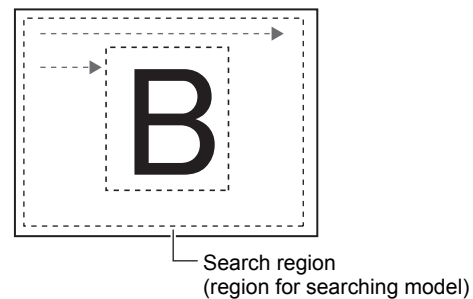

### Note

With the grouping function, automatic setting of the number of defects is not executed even in screens with the [AUTO] button.

## Region settings

This function sets the region to be registered as the model and the region to search for the model.

### ► MENU mode - [Setup] - [Item] - [Region]

Item	Description
Register model	This function registers the image pattern to find as the model.  Setting the Region p.194
Reference model	The image that is registered as the model can be referenced.
Search region	Set the region in which to search for the model.

## Threshold

This function sets the judgment conditions.

### ► MENU mode - [Setup] - [Item] - [Limits]

Setup Item	Description
Correlation	Sets the range of the correlation to be judged as OK. Range: 0 to 100
Position XY	Sets the range of movement in the X- and Y- axes of the measurement target to be judged as OK. Range: -9999.999 to 9999.999 (When calibration is OFF, the range of movement for positions X and Y are 0 to 640 and 0 to 480, respectively.)
Index No.	Sets the range of index Nos. to be judged as OK. Range: 0 to 63

## Image adjustment (if necessary)

The following items can be changed and set to the image of the measurement target.

### ► MENU mode - [Setup] - [Item] - [Img Adj]

Item	Description
Select camera	 For details, see "Image Adjustment". p.94
Color filter	
Filtering	
BGS* level	

## Detailed settings (if necessary)

When measurement is not stable, adjust the detailed conditions.

### ► MENU mode - [Setup] - [Item] - [Detail]

Setup Item	Setting value	Description
Search mode	Hi-speed	The search is performed at high speed.
	Normal (default value)	The search is performed in the normal mode for both speed and precision.
	Precision	The position is calculated at high precision in sub-pixel units (units smaller than pixels).
Verification	OFF (default value)	The search is performed in detail near a candidate point having the highest correlation value.
	ON	The search is performed in detail near all candidate points. Select [ON] when the model cannot be searched for stably.
Candidate level	0 to 100 (default value: 60)	Sets the level at which the model is searched for during a rough search. Images having a correlation value at the candidate level or more are taken to the candidate points in the Verification. Set a lower level when the model cannot be searched for stably.
Calibration	OFF (default value)	Measurement results are output using the camera's coordinate values.
	ON	Measurement results are output using the coordinate value converted by the calibration function.
Coordinates mode	Normal (default value)	The position information of the input image coordinate system itself is output.
	Pos. correction	When position shift correction is set, the position information is output using the coordinate system corrected to the original state when the coordinate system was registered.



- Verification and candidate level p.49
- Coordinates mode p.74

## Possible output results

The following values can be output when expressions are set.

Item	Description	Message
Judgment result	The judgment result is output. (0:OK, -1:NG, -2: not measured)	Judge (JG)
Correlation	The degree of match between the measurement image and model image are output as a correlation value. (0 to 100)	Correlation (CR)
Measurement position	The X, Y coordinates of the position where the model was found are output. (-9999.999 to 9999.999)	Position X, Y (X, Y)
Index No.	Outputs the No. of the model having the highest correlation. (0 to 63)	Index No. (IN)

## Defect

Use this item to detect dirt, scratching, chipping, burrs, and other defects on plain measurement targets. The extent of the defects at locations having the highest number of defects and their positions are output. The number of locations where the extent of defects equals or exceeds the noise level also are output.

### Setup

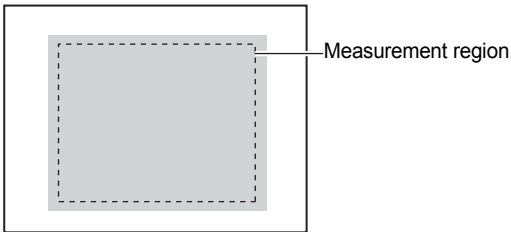

### Measurement

The measurement region is automatically subdivided into smaller sections to detect for changes in their respective brightness (density). The density difference with the surrounding area is collected, parts having a large difference are judged to be a defect, and the position information and extent of the defects of the locations having the highest number of defects are output.

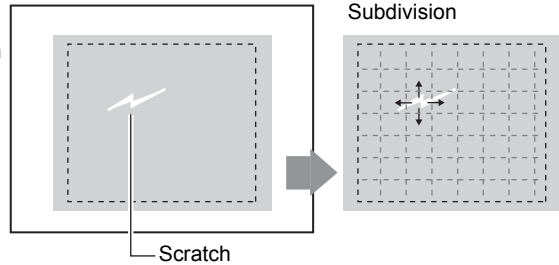

Chipping and burrs on the outer periphery also can be detected.

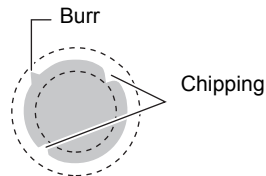

### Note

### Number of Defects

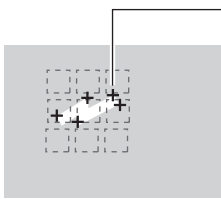



The extent of the defects is calculated in subdivided regions, and regions at or exceeding the defect threshold are output as the number of defects.

## Region settings

Set the measurement region.

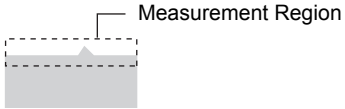
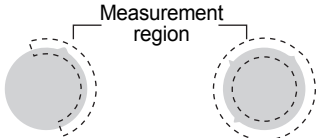
### ► MENU mode - [Setup] - [Item] - [Region]

Item	Description
Measurement Region	<p>This function sets the region to be measured.</p> <p> Setting the Region p.194</p> <p>Inspection is classified into the following four inspections for each region setup.</p> <ul style="list-style-type: none"> <li>• Line Select this item to inspect measurement targets for chipping, burrs and other defects. The shape that can be drawn is one straight line.</li> </ul> <p></p> <ul style="list-style-type: none"> <li>• Circum/Arc Select this item to inspect round measurement targets for chipping, burrs and other defects. The shape that can be drawn is one circumference or arc.</li> </ul> <p></p> <ul style="list-style-type: none"> <li>• Area Select this item to inspect the entire measurement target for scratches and dirt. A combination of up to five shapes (rectangles, ellipses, circles, polygons).</li> </ul> <p></p>
Reference registration	<p>When the measurement region is set, measurement is executed on the display image, and the result of execution is registered as the reference value. To re-register only reference values, you can use this function to re-register only reference values based on the image currently on screen.</p>

## Threshold

This function sets the judgment conditions.

### ► MENU mode - [Setup] - [Item] - [Limits]

Setup Item	Description
Defect	Sets the defect judgment value to be judged as OK. Range: 0 to 255
Density	Sets the density range to be judged as OK. Range: 0 to 255
Number of defects	Sets the range of number of defects to be judged as OK. Range: 0 to 255

## Image adjustment (if necessary)

The following items can be changed and set to the image of the measurement target.

### ► MENU mode - [Setup] - [Item] - [Img Adj]

Item	Description
Select camera	 For details, see "Image Adjustment". p.94
Color filter	
Filtering	
BGS level	

## Detailed settings (if necessary)

When measurement is not stable, adjust the detailed conditions.

### ► MENU mode - [Setup] - [Item] - [Detail]

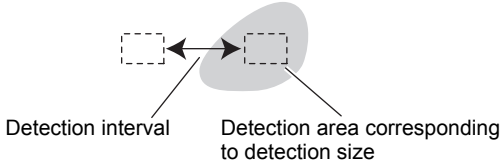
Setup Item	Setting value	Description
Detection size	4 to 64 (default value: 8)	Creates a small detection area corresponding to the detection size inside the measurement region.
Detection interval	4 to 64 (default value: 8)	<p>The average density is calculated for each detection area. The average density of the detection area is then compared with the surrounding average density, and the defect position is detected by how much the average density differs with the surrounding area. The difference with the average density that was the largest is output as the defect value.</p>  <p style="text-align: center;"> <span style="margin-right: 100px;">Detection interval</span> <span>Detection area corresponding to detection size</span> </p>
Noise level	0 to 255 (default value: 60)	Places having a defect value lower than the noise level are removed as the noise component, while places having a defect value higher than the noise level are counted as defect positions.
Calibration	OFF (default value)	Measurement results are output using the camera's coordinate values.
	ON	Measurement results are output using the coordinate value converted by the calibration function.
Coordinates mode	Normal (default value)	The position information of the input image coordinate system itself is output.
	Pos. correction	When position shift correction is set, the position information is output using the coordinate system corrected to the original state when the coordinate system was registered.

 Coordinates mode p.74

**Note** Guidelines for setting detection size and detection interval

## • Detection size

Determine the detection size roughly according to the size of the defect to be detected.

Setting a smaller detection size results in stronger detection sensitivity, while setting a larger detection size results in weaker detection sensitivity.

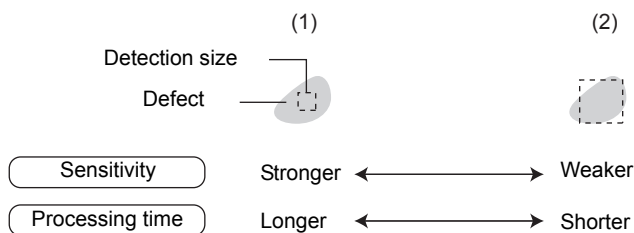

When a larger detection size is set, the difference with elements that are not defects decreases as the density of elements other than defects also is included in the calculation at (2). In other words, the more background that is included in the detection area, the weaker the detection sensitivity becomes.

## • Detection interval

Determine the detection interval roughly according to the size of the defect and the detection size.

The larger the detection interval that is set, the shorter the processing time becomes.

When the detection area is greater than the defect, set a smaller detection interval.

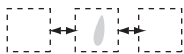

When the defect is greater than the detection area, set a slightly larger detection interval.

When a small detection interval is set, elements overlapping the edge of the defect also are included in the comparison, and so the defect value decreases, which results in less stable detection of the defect.

**Possible output results**

The following values can be output when expressions are set.

Item	Description	Message
Judgment result	The judgment result is output. (0:OK, -1:NG, -2: not measured)	Judge (JG)
Defect	Measured extent of defects is output. (0 to 255)	Defect (F)
Maximum density	The maximum density value inside the measurement region is output. (0 to 255)	Max. density (GH)
Minimum density	The minimum density value inside the measurement region is output. (0 to 255)	Min. density (GL)
Number of defects	The number of defects having an extent of defects at or exceeding the judgment condition is output. (0 to 255)	Number of defects (N)
Defect position	The X, Y coordinates of the defect position are output. (-9999.999 to 9999.999)	Position X, Y (X, Y)
Reference position	The X, Y coordinates of the defect position when the measurement region is drawn are output. (-9999.999 to 9999.999)	Reference X, Y (SX, SY)
Position difference	The difference obtained by "measurement position - reference position" is output. (-9999.999 to 9999.999)	Position dif. X, Y (DX, DY)

For details on reference position, position difference p.50

# Image Adjustment

This section describes the functions for apply filters, etc. to process images captured from the camera so that they can be easier-to-measure. Items that can be set differ according to the measurement item and type of camera. Only available items are displayed.

## Select Camera

Select camera 0 or camera 1 as the camera to be used in this measurement item.

▶ **MENU mode - [Setup] - [Item] - [Img Adj]-[Select camera]**

## Color Filter

The contrast of images can be improved by passing images through color filters. This function can be set only when a color camera is connected to the Controller. When a color filter setting is changed, a new image processed by the color filter is displayed on the right side of the monitor. Set the color filter while monitoring the image on screen.

**Note** **AUTO Setting p.168**

When AUTO is set for measurement items that support use of color filters, the optimum color filter is automatically set.

 Color Filter p.202

▶ **MENU mode - [Setup] - [Item] - [Img Adj] - [Select camera] - [Color filter]**

Item	Description
Select filter	The color filter can be selected as desired. (Red, Blue, Green, Yellow, Cyan, Magenta, Gray, Custom) When [Custom filter] is selected, any color in the color bar can be set to the filter.
Auto function	Sets whether or not to perform automatic selection of color filter processing when the automatic setting is executed. On: The current image is analyzed to automatically select the optimum color filter each time that the automatic setting is executed. Off: The currently selected color filter is fixed, and is not cleared and held even if the automatic setting is executed.



## Color Pickup/Binary

This function picks up the color to be measured.

### When a color camera is connected to the Controller

#### ► MENU mode - [Setup] - [Item] - [Img Adj] - [Select camera] - [Color Pickup]

Item	Description
Region	When an area containing a color to be measured is specified, and [AUTO] is selected, up to four colors are automatically picked up in order of the color having the largest area.
Pickup Color	If the appropriate image is not obtained by automatic color pick up, the three parameters hue, saturation and brightness can be fine-adjusted for each candidate color. When [Auto function] is set to [OFF], the color pick up is not updated when the automatic setting is next executed. To exclude a specific color from the measurement target, set [Enable/Disable] to [Disable].

 Color Pickup, p.204

### When a monochrome camera is connected to the Controller

#### ► MENU mode - [Setup] - [Item] - [Img Adj] - [Select camera] - [Binary]

Item	Description
Binary level	Sets the level for converting contone images made up of 256 tones captured from a camera to binarized images. As white pixels are targeted in measurement, the binary level is adjusted so that the measurement target is transformed into white pixels.
Reverse	Reverses the black and white of binary images. After the image is inverted, the area converted to white pixels is the measurement target.

## Pre-processing

This function processes images captured from the camera so that they can be easier-to-measure. Eight filtering options are available so that you can set filtering different for each of position correction and actual measurement.

When you move the cursor, a filtered image of the image at the cursor position is displayed on the right side of the monitor. Set the filter while monitoring the image on screen.

### ► MENU mode - [Setup] - [Item] - [Img Adj] - [Select camera] - [Filtering]

Filtering	Target Image	Description of Filtering
OFF (default value)	-	-
Smooth	Measurement targets containing slightly unevenness	Creates a cloudy effect to soften the unevenness.
Erosion	Black measurement targets containing white noise	Reduces the white component to eliminate the noise.
Dilation	White measurement targets containing black noise	Spreads the white component to eliminate the black noise.
Median	Measurement targets containing slightly unevenness	Softens the unevenness while keeping the image contour intact.
Sharpen	Measurement targets containing fuzzy areas (fluctuating lighting, etc.)	Enhances the border lines between light and dark areas in the image.
V Edge	Images that are difficult to pick up due to poor contrast	Picks up the vertical border lines (contrast) in the image.
H Edge	Images that are difficult to pick up due to poor contrast	Picks up the horizontal border lines (contrast) in the image.
All Edge	Images that are difficult to pick up due to poor contrast	Picks up all border lines (contrast) in the image.

#### Note Filter Strength

The filter strength can be selected when applying the filtering options to images. Each selection of the [5x5 filter]/ [3x3 filter] in the filtering setup screen toggles the filter strength.

## Background Suppression

This function removes unwanted background from the images to exclude them from the measurement target. Setting the BGS level converts images at the lower limit value or below to density 0 and images at the upper limit or above to density 255 so that only an image of density within the range lower limit value to upper limit value is extended and turned into a measurement target having 0 to 255 tones. When you move the cursor, an image of the image at the cursor position is displayed at the cursor position with unwanted background removed. Set the BGS level while monitoring the image on screen.

Example: Set the lower limit value to 100 and upper limit value to 220

Image before background is removed    Image with background removed

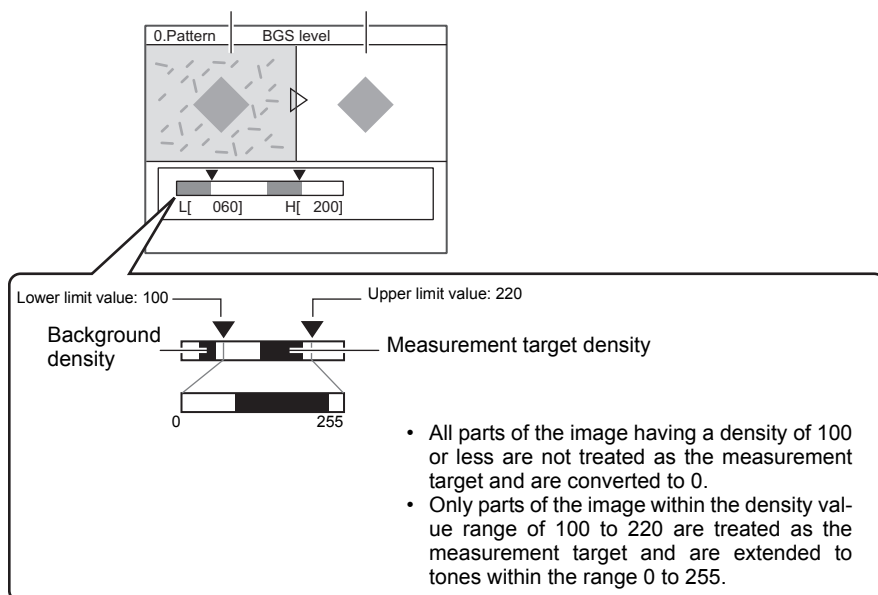

► MENU mode - [Setup] - [Item] - [Img Adj] - [Select camera] - [BGS level]

# Cameras/Lighting

Set the camera and lighting operating conditions for capturing images and measuring measurement targets in an optimum state.

## Shutter Speed

Set the shutter speed to match the speed of movement of the measurement target and the lighting environment.

The type of camera that is connected is automatically recognized, and only shutter speeds that can be set are displayed.

 List of Available Functions for Each Camera p.167

### ► MENU mode - [Setup] - [Cameras] - [Camera 0/1] - [Shutter Speed]

Setting value	Description
1/170 to 1/20000 s	Fixes the shutter speed to the desired value. Only available candidate shutter speeds are displayed. The candidates differ with the camera that is connected and setup conditions.

#### **Note** Guidelines for setting shutter speed

Shutter speed characteristics are as follows. Select the appropriate shutter speed to suit your inspection requirements.

Shutter Speed	Speed of Movement of Measurement Target
1/170 s	Slow
•	•
1/20000 s	Fast

## Gain Setting

The sensor's gain (sensitivity) can be adjusted if bright images cannot be obtained just by the Shutter Speed and Light Control settings.

### ► MENU mode - [Setup] - [Cameras] - [Camera 0/1] - [Gain]

Setting value	Description
x 1.0, x 1.5, x 2.0	Sets the gain factor. x 1.0: The gain factor is not changed. (default value) x 1.5: The gain factor is set to 1.5X. x 2.0: The gain factor is set to 2.0X.

#### **Note** Guidelines for setting gain

Increasing the gains results in a brighter image, however, the noise component contained in the image also becomes more conspicuous. Select the appropriate gain factor to suit your inspection requirements.

Gain	Image	Image Quality
x 1.0	Dark	Good (little noise)
•	↑↓	↑↓
x 2.0	Bright	Coarse (conspicuous noise)

## Partial Function Settings

Set the image capture area. Limiting the image capture area in this way speeds up processing.

The items that can be selected by this function change according to the camera connected to the Controller and shutter speed conditions.

 List of Available Functions for Each Camera p.167

### Important

When the partial function setting is changed, the size of the input image also changes. When the partial function setting has been changed, set the measurement conditions including the model conditions of measurement items and position shift compensation again.

### ► MENU mode - [Setup] - [Cameras] - [Camera 0/1] - [Partial Function]

Each selection of [Size] switches the image capture area in the following order:

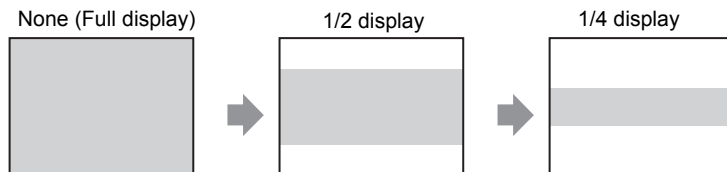

### Note Adjustment of Image Capture Area

When 1/2 display or 1/4 display is displayed, the capture area can be adjusted up and down.

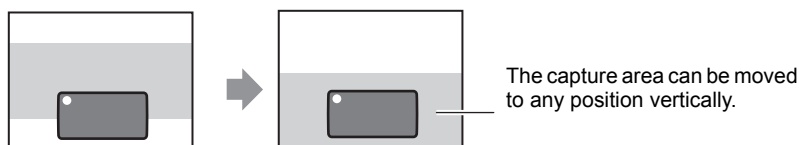

## Image Rate

Set the Image Rate mode for capturing images. Setting a faster image rate increases the processing speed, though precision becomes worse.

The items that can be selected by this function change according to the camera connected to the Controller and shutter speed conditions.

 List of Available Functions for Each Camera p.167

### Important

When the Image Rate mode is changed, the size of the input image also changes. When the partial function setting has been changed, set the measurement conditions including the model conditions of measurement items and position shift compensation again.

### ► MENU mode - [Setup] - [Cameras] - [Camera 0/1] - [Image Rate]

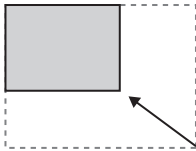
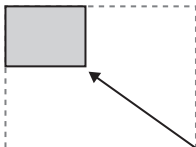
Setting value	Description
Fine	The image is captured at normal size. (default value)
Normal, High speed	<p>The image is captured and then compressed.</p> <div style="display: flex; align-items: flex-start;"> <div style="margin-right: 20px;">  </div> <div> <p>Normal: 2 pixels each in the horizontal and vertical directions are compressed to 1 pixel when they are captured.</p> </div> </div> <div style="margin-top: 10px;">  </div> <div style="margin-top: 10px;"> <p>High speed: 4 pixels each in the horizontal and vertical directions are compressed to 1 pixel when they are captured.</p> </div>

# Light Control (Recipe Functions)

This recipe type function enables you to determine the lighting just by selecting the image that meets your specific requirements from the thumbnails of images automatically captured under different illumination patterns. This allows the number of man-hours taken to finalize the lighting conditions to be greatly reduced. The amount of emitted light can also be fine-adjusted after the illumination pattern is selected from the recipe.

This item is displayed only when a camera that supports this function is connected to the Controller.

 List of Available Functions for Each Camera p.167

## Note

When adjusting optional lighting connected to the ZFX-SR\_\_/SC\_\_ or adjusting the lighting intensity of the ZFX-SC150, only ON/OFF control is available. The recipe function and intensity cannot be adjusted.

Place the camera with lighting at the specified distance, adjust the focus and perform the following.

### ▶ MENU mode - [Setup] - [Cameras] - [Camera 0/1] - [Light Control]

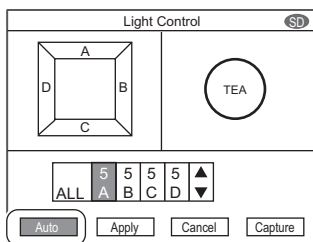

## 1 Select the [AUTO] button.

An image obtained by altering the illumination pattern is captured.

## Note

The amount of emitted light of each block (A onwards) is adjusted as the illumination pattern. The shutter speed is not changed.

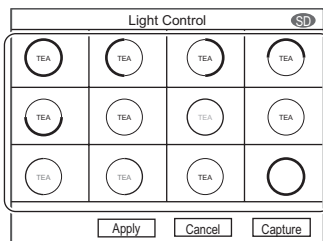

## 2 Select the image that meets your specific requirements from the thumbnails displayed on screen.

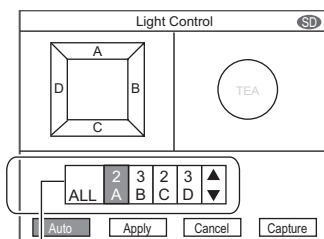

Amount of emitted light

## 3 The lighting conditions of the selected image are displayed. Fine-adjust these conditions as required.

## Note How blocks are displayed

Example: When the ZFX-SR\_\_/SC\_\_ is connected

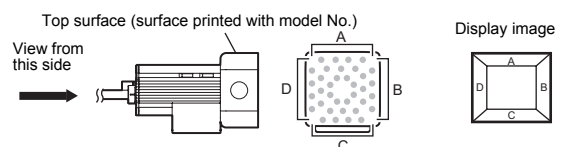

- The number of division blocks differs according to the camera.
- The larger the number for the amount of emitted light, the brighter the image becomes. 0 indicates that illumination is off.

# Calibration

This function converts measurement values from pixels to actual dimensions for output. By setting the relationship between camera coordinates and actual coordinates, measurement results expressed in pixels can be converted to actual dimensions and output.

**Note**

To enable the calibration function, set [Calibration] in the Detail setup screen for each measurement item to [ON]. When [Calibration] is still [OFF] (default value), measurement values are output using camera coordinates and not the actual dimensions.

Pixel units can be converted to actual dimensions and output.

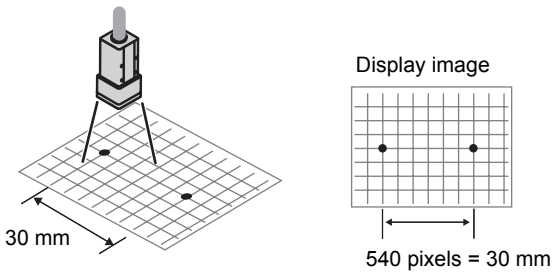

Both the origin and the coordinate system can be corrected.

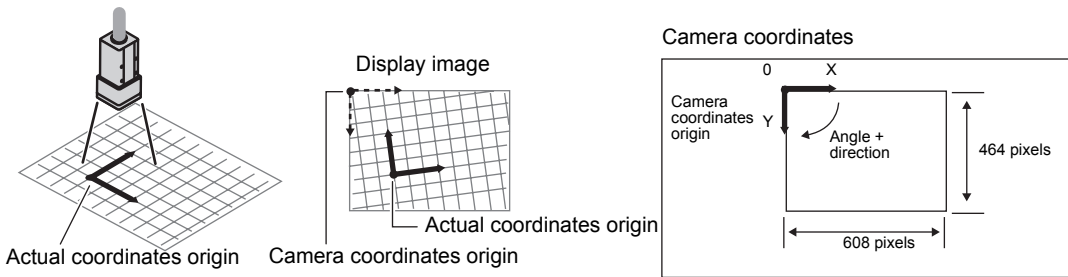

Three calibration setup options are available: "Sampling input", "Specifying point" and "Parameter Input".

## Setting Calibration by Sampling Input

With this method, calibration is set based on the measurement results. First, a pre-registered model is measured to find its position (in sub-pixel units). When the actual coordinates of the position that was found is input, the calibration data is automatically calculated.

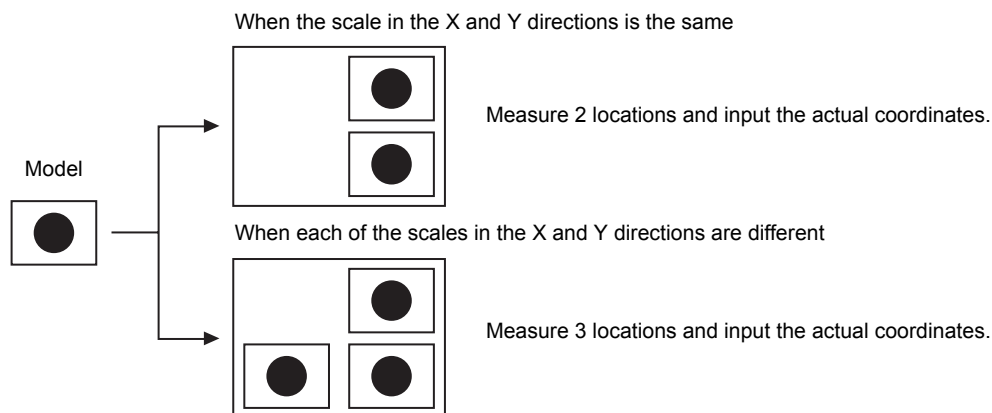

## Setup method

### Image adjustment

The image adjustment function can be set for calibration measurement.

#### ► MENU mode - [Setup] - [Cameras] - [Camera 0/1] - [Calibration] - [Sampling input] - [Img Adj]

Item	Description
Color filter	 For details, see "Image Adjustment". p.94
Filtering	
BGS level	

### Registering the model

Register the model to be used for calibration.

#### ► MENU mode - [Setup] - [Cameras] - [Camera 0/1] - [Calibration] - [Sampling input] - [Region]

Item	Description
Region	Registers the model to be used for calibration.
Search region	Sets the region in which to search for the model.



## Executing a search

Perform an actual search, and input the actual coordinates of the location where the model was found. Before performing an actual search, register the model to be used in the search at [Region].

► MENU mode - [Setup] - [Cameras] - [Camera 0/1] - [Calibration] - [Sampling input] - [Sampling]

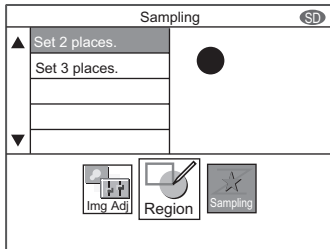

**1** Select either [Set 2 places.] or [Set 3 places.].

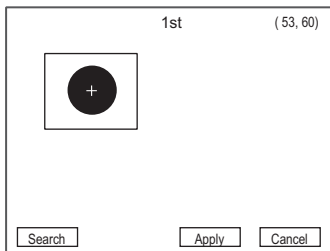

**2** Place the measurement target and select [search].

The search is executed, and a frame and crosshair cursor are displayed at the location where the model was found.

**3** Select [Apply].

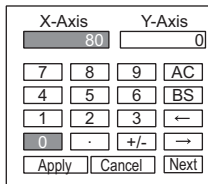

**4** Input the actual coordinates of the 1st point.

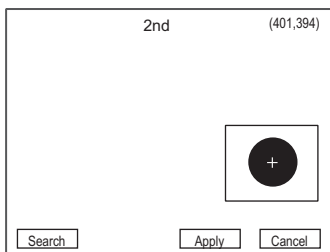

**5** Move the measurement target to the 2nd point and select [Search].

**6** Select [Apply].

**7** Input the actual coordinates of the 2nd point.

When sampling 3 points, repeat steps 4 to 6.

## Setting Calibration by Specifying Points

With this method, calibration is set by specifying desired points (in pixel units). When the actual coordinates of a specified position are input, the calibration data is automatically calculated.

When the scale in the X and Y directions is the same

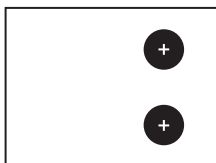

Specify 2 locations and input the actual coordinates.

When each of the scales in the X and Y directions are different

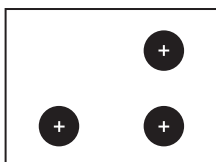

Specify 3 locations and input the actual coordinates.

### Setup method

► MENU mode - [Setup] - [Cameras] - [Camera 0/1] - [Calibration] - [Specifying point]

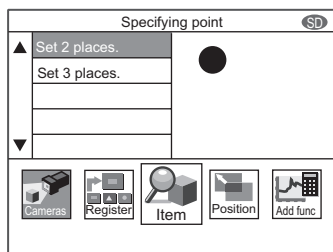

**1** Place the measurement target at the 1st point, and select either [Set 2 places.] or [Set 3 places.].

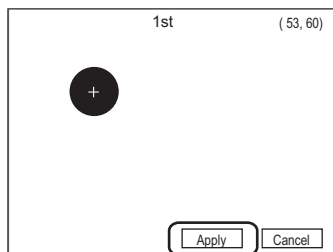

**2** Move the crosshair cursor to the 1st point, and select [Apply].

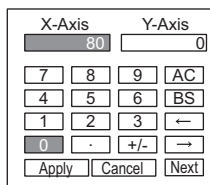

**3** Input the actual coordinates of the 1st point.

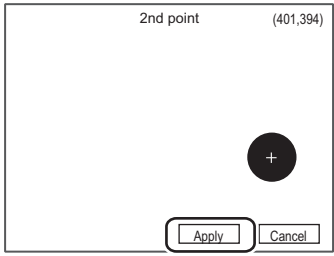



**4** Move the crosshair cursor to the 2nd point, and select [Apply].

**5** Input the actual coordinates of the 2nd point.  
When specifying 3 points, repeat steps 4 to 5.

## Setting Calibration by Parameter Input

With this method, calibration is set based by directly inputting numerical values. When the origin and coordinate system of the actual coordinates, and pixel magnification are input, the calibration data is calculated.

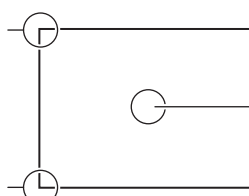
► MENU mode - [Setup] - [Cameras] - [Camera 0/1] - [Calibration] - [Parameter Input]

Setting value	Description
Origin	Specify where the origin of the actual coordinates is to be set.  <div style="display: flex; align-items: center; justify-content: center;"> <div style="text-align: left; margin-right: 10px;">Upper left of display</div>  <div style="margin-left: 10px;">Center of display</div> </div> <div style="display: flex; align-items: center; justify-content: center;"> <div style="text-align: left; margin-right: 10px;">Lower left of display</div>  </div>
Magnification	Sets how much of the actual dimensions one pixel is to be equivalent to. (0.010 to 9.999)

**Note**

The coordinate system used for expressing the actual coordinates is the left-handed coordinate system. The plus direction of the angle is as follows depending on the origin setting.

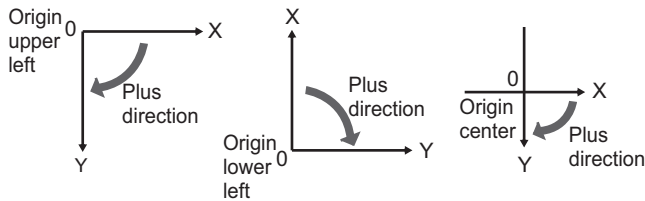

# Registering Images

This function is for making a series of settings using the same image. Two images can be registered in the Controller's internal memory, and called up so that they can be used for use in setup.

The following three types of images can be registered:

- Live images from a camera connected to the Controller
- Measurement images saved on the Controller
- Images saved on SD card

The following operation is not required when making setups using live images. Also, registered image data is cleared when the Controller is turned OFF. To retain image data, save them on SD card.

## Selecting operation

### ▶ MENU mode - [Setup] - [Register] - [Image 0/1]

Setting value	Description
Register image	Selects the image to be registered. Live image: Registers the image captured from camera 0 or camera 1. Stored image: Registers the stored measurement image. Image in SD card: Registers the image saved in SD card.
Save to SD card	Saves the registered image on SD card. The folder "IMAGE" is automatically created on SD card, and is saved using the following folder names. One image file each can be saved, and the image file is overwritten when the registered image is next saved on SD card. Image 0: REGIMG00.BYR Image 1: REGIMG01.BYR
Delete image	Deletes the registered image.

## Using registered images

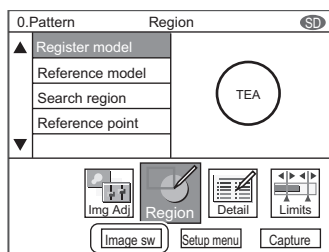

The following settings can be made to registered images:

- Image adjustment
- Region settings

Switch between live images and registered images by selecting [Image sw] that is displayed in each of the above menu hierarchies.

# Position Correction

This function is used when the position or orientation of the measurement target is not fixed. If you use this function, the amount of the shift from the reference position is calculated, and the position of the measurement region is corrected before measurement is performed.

## Important

After using an image for setting position correction, save the image to SD card.

 Registering Images p.106

When adjusting by position correction, use a saved image. If you use an image different from the one that was initially set to perform adjustments, position correction might not be set correctly.

To perform adjustments with a different image, repeat the settings for measurement items, too.

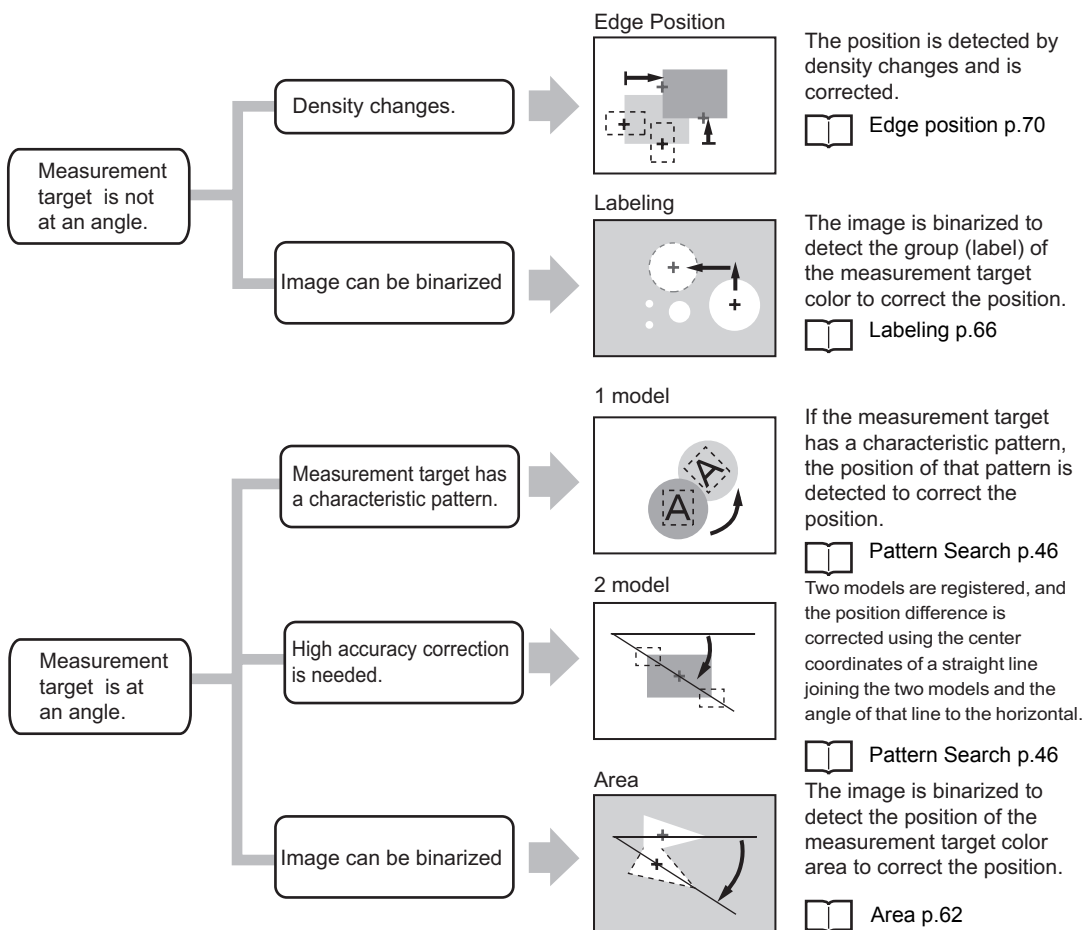

## Note

- This section describes guidelines for selecting position correction items. The setup parameters for each item are the same as those for the measurement items. For details, see those items.
- Normally, a single position correction is sufficient. However, to ensure reliable correction of positions or to shorten the processing time, correct the position in 2 stages. [Position0] is the correction performed for the 1st position correction, and [Position1] is the correction performed for the 2nd position correction.

The direction in which shift can be corrected automatically turns [ON] according to the preset position correction method. Change the setting for directions to exclude from position correction to [OFF].

► **MENU mode - [Setup] - [Position] - [Camera 0/1] - [Position0/1] - [Correction setting]**

Setting value	Description
X correction	Correct shift in the X direction.
Y correction	Correct shift in the Y direction.
$\theta$ correction	Corrects shift in the rotary direction. Items not supported in correction of shift in the rotary direction are not displayed.

# Additional Functions

## Calculation

The ZFX-C can output two types of data (measurement values and judgment values) to external devices. Output content is set as calculation expressions.

### Measurement values/judgment

The measurement values and judgments of each region can be output. As the output content can be set as an expression, calculations can be made with the measurement values of other regions. Up to 32 expressions can be set.

► MENU mode - [Setup] - [Add func] - [Calculation] - [Data] or [Judge]

Setting value	Description
Data	The measurement value is output. Up to 32 expressions, 0 to 31, can be set.
Judgment	The judgment is output. Up to 32 expressions, 0 to 31, can be set. Judgment conditions can be set for each expression.

#### Note

Select the output destination at [System] - [Output].



p.132

### Variables

Calculation expressions that are not output to external devices can be set. These expressions are called "variables". You can set frequently used expressions or part of long expressions that cannot fit into the maximum number of digits of calculation expressions, and you can reference variables from other calculation expressions. Up to 32 expressions can be set.

► MENU mode - [Setup] - [Add func] - [Calculation] - [Variables]

Setting value	Description
Variables	Up to 32 expressions, 0 to 31, can be set. Judgment conditions can be set for each expression.

## Setup Parameters

### Item No.

Item Nos. are displayed as follows.

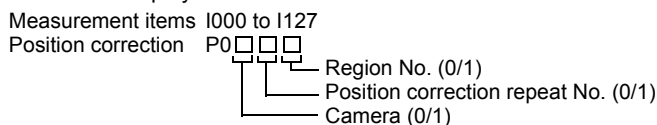

The parameters that can be set to expressions differ according to the measurement item.

 "Possible output results" from measurement items

### List of functions

The following describes the functions that are available for expressions.

#### General functions

Function	Description
ABS	Calculates the absolute value. ABS (argument)
MOD	Calculates the remainder obtained by dividing the dividend by the ordinal. MOD (dividend, ordinal) If the numerical value to be handled is a real number when calculating the remainder, numbers past the decimal point of the real number are rounded to the nearest whole number before calculation of the remainder is executed. The result is the remainder of division of the integer. Example: MOD(13,4)... Result: 1 (remainder obtained by dividing 13 by 4) MOD (25.68,6.99)... Result: 1 (remainder obtained by dividing 26 by 7)
MAX	The largest value of the four arguments is returned. MAX (argument 1, argument 2, argument 3, argument 4)
MIN	The smallest value of the four arguments is returned. MIN (argument 1, argument 2, argument 3, argument 4)
SQRT	Calculates the square root. When the argument is a minus number, "0" is returned as the calculation result to indicate that the judgment result is an NG. SQRT (argument)
AVE	Calculates the average. AVE (Up to 4 arguments can be set.)

#### Trigonometric functions

Function	Description
SIN	Calculates the sine. The result is returned in the range -1 to 1. Specify the angle in the numerical expression in degrees. SIN (numerical expression)
COS	Calculates the cosine. The result is returned in the range -1 to 1. Specify the angle in the numerical expression in degrees. COS (numerical expression)



Function	Description
ATAN	<p>Calculates the arc tangent of the Y-axis and X-axis components. The result is returned as a radian in the range <math>-\pi</math> to <math>\pi</math>. ATAN (Y-axis component, X-axis component)</p> <p>Example: To calculate the angle formed between a horizontal line and a straight line joining the gravities of items 0 and 1 ATAN (I001.Y-I000.Y, I001.X-I000.X)</p> <p>When both of the two arguments are 0, 0 is returned as the calculation result to indicate that the judgment is NG.</p>

### Geometrical functions

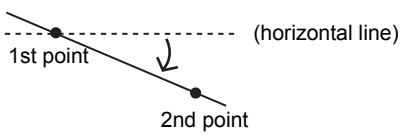
Function	Description
ANGL	<p>Calculates the angle formed by a straight line connecting two points (gravity and center of model). The angle is calculated with respect to the horizontal line. The result is returned in the range -180 to 180. ANGL (Y-axis component, X-axis component)</p> <p>Example: To calculate the angle formed by a straight line joining the gravities of items 0 and 1 ANGL (I001.Y-I000.Y, I001.X-I000.X)</p>  <p>When both of the two arguments are 0, 0 is returned as the calculation result to indicate that the judgment is NG.</p>
DIST	<p>Calculates the distance between two points (gravity and center of model). DIST (X-axis coordinate of 1st point, Y-axis coordinate of 1st point, X-axis coordinate of 2nd point, Y-axis coordinate of 2nd point)</p> <p>Example: To calculate the distance between the gravities of items 0 and 1 DIST (I000.X, I000.Y, I001.X, I001.Y)</p> <p>The following calculation is performed internally:</p> $\sqrt{(I001.X-I000.X)^2 + (I001.Y-I000.Y)^2}$

### Logic functions

Function	Description
AND	<p>Calculates the logical product. When either of the arguments is "0", "0" is returned as the calculation result, and "-1" is returned for the other argument. AND (argument1, argument 2)</p>
OR	<p>Calculates the logical sum. When both of the arguments is "0", "0" is returned as the calculation result, and "-1" is returned for the other argument. OR (argument1, argument 2)</p>
NOT	<p>Calculates the logical NOT. NOT (argument1, argument 2)</p>

## List of operators

The following describes the arithmetic operators that are available for expressions.

Operator	Description of Operation
+	Addition
-	Subtraction
*	Multiplication
/	Division of real numbers

## Setting Reflection of Individual Results

You can select which item results are to be reflected in the overall judgment that is output to the OR signal of the parallel interface.

### Note

The overall judgment result can be checked in the RUN mode or ADJ mode.

### ► MENU mode - [Setup] - [Add func] - [OR setting]

Setting value	Description
Measurement item	Sets measurement items to be included in the overall judgment to [ON]. Range: ON (default value), OFF
Position correction item	Sets position correction items to be included in the overall judgment to [ON]. Range: ON (default value), OFF
Calc./variable	Sets whether or not include the results of [Calculation/Variable] in the overall judgment. Range: ON (default value), OFF
Calc./judge	Sets whether or not include the results of [Calculation/Judgment] in the overall judgment. Range: ON (default value), OFF
Calc./alarm	Sets whether or not to include the [Calculation/Logging Monitor] alarm in the overall judgment. Range: ON, OFF (default value)

# Logging Monitor

This function displays a log of the measurement results on the monitor. By observing the trends of measurement values, you can prevent frequent occurrence of defective products, and you can use this information to analyze the cause of NGs that occur.

Up to three parameters can be logged and monitored simultaneously, and up to 10,000 items of data can be held in a single parameter.

 How Items Are Displayed on the Logging Monitor p.118

## Setting

### Log Settings

The following explains the data to be logged and the conditions used as the trigger for generating a warning.

▶ **MENU mode - [Setup] - [Add func] - [Logging monitor] - [Log0/1/2] - [Modify]**

Setup Item	Description
Reference data	<p>Sets the measurement values to be displayed on the logging monitor as a calculation expression.</p> <p>Up to three parameters from among Measurement item, Position correction item, Variable, or Data can be logged and monitored simultaneously.</p> <p> How to set calculation expressions p.109</p>
Warning Condition	Sets the warning range to prompt the operator to be alert before NGs frequently occur.
Logging	<p>Selects logging On/Off.</p> <p>Range: On, Off (default value)</p>

### Display condition

Sets the conditions for displaying data on the logging monitor.

▶ **MENU mode - [Setup] - [Add func] - [Logging monitor] - [Display condition]**

Setup Item	Description
Warning Count	<p>Specify to the warning range the allowable number of consecutive NGs before the warning is to be generated.</p> <p>Range: 1 to 999 (default value: 1)</p>
Display average	<p>Selects whether or not to display the average in the graph display on the logging monitor. This setup item is enabled when the graph display scale is set to value greater than 200 (results).</p> <p>The graph display scale can be changed in the ADJ mode.</p> <p>Range: OFF (default value), ON</p>
Display maximum Display minimum	<p>Select whether or not to display the minimum and maximum values in the graph display on the logging monitor.</p> <p>This setup item is enabled when the graph display scale is set to value greater than 200 (results).</p> <p>The graph display scale can be changed in the ADJ mode.</p> <p>Range: OFF (default value), ON</p>

**Note**

The display range of the graph's horizontal and vertical axes can be changed in the ADJ mode.

 Adjusting Logging Monitor Conditions p.123

## Erasing Measurement Values

This function allows you to erase (reset) accumulated data without having to turn the Controller OFF.

► **MENU mode** - [Setup] - [Add func] - [Logging monitor] - [Log0/1/2] - [Erase]

## File Format

The format of files saved on SD card are as follows:

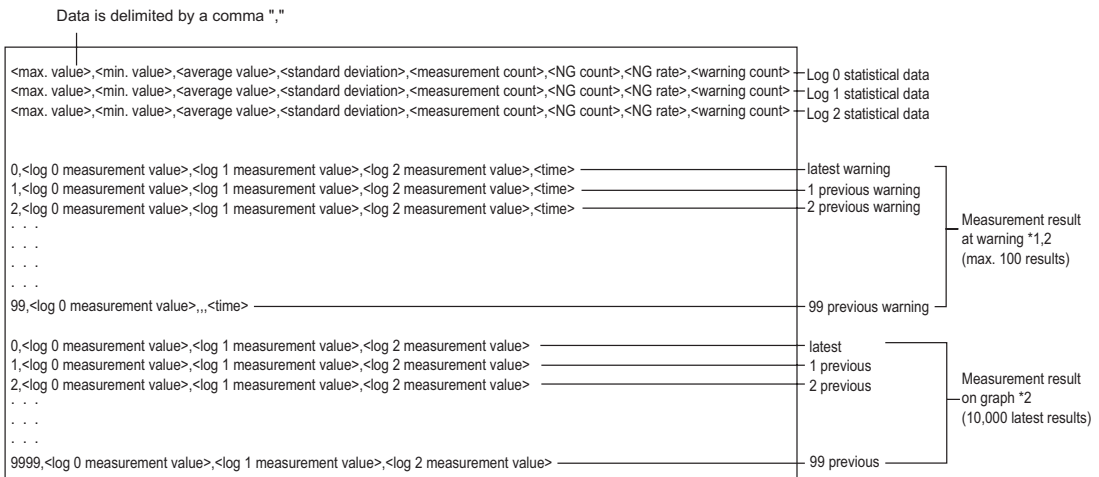

\*1: When a warning is inserted consecutively for even one of logs 0 to 2, the measurement values are logged.

\*2: Commas are aligned where logs are not set.  
Example: 1,<measurement value>,...,<time>

**Note**

### Difference between NG count and warning count

The "NG count" is the number of times that the measurement value exceeds or falls below the warning level.

The "warning count" is the number of times that the measurement value exceeded or fell below the warning level continuously for the number of times set for the warning count or more in the setup conditions.

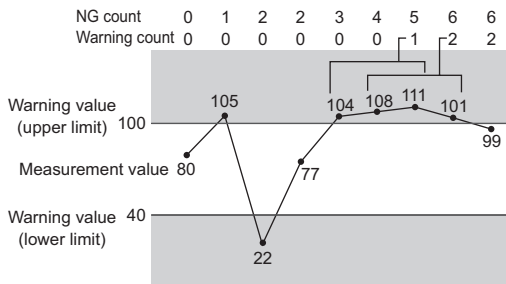

 Saving/Loading Data p.140

# FUNCTIONS USED DURING OPERATION

---

<b>Monitoring the Measurement Status - RUN Mode</b>	<b>116</b>
Displaying Measurement Information	116
Switching the Image Display Method	118
<b>Checking/Adjusting the Measurement - ADJ Mode</b>	<b>119</b>
Checking Measurement Status	119
Switching the Image Display Method	121
Using a Saved Image to Perform Re-measurement	121
Adjusting Measurement Conditions	122

# Monitoring the Measurement Status - RUN Mode

## Displaying Measurement Information

Measurement information is displayed on the LCD screen. You can switch the screen to display different measurement information according to your specific application. To switch the screen display, either select [Display SW] or press the F3 key.

### Individual results

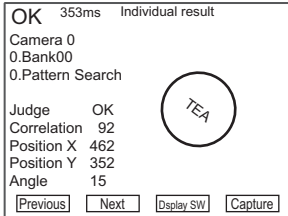

Results are displayed individually for each measurement item.

### All results/Region

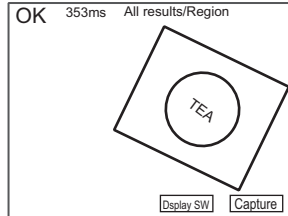

The entire measurement region is displayed.

### All results/Judge

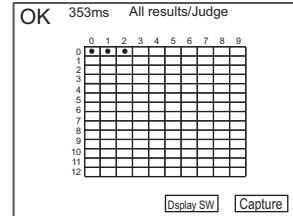

All measurement results are displayed as a list.

Horizontal axis: Smallest digit of item No.  
Vertical axis: Upper two digits of item No.  
Green circle: OK  
Red circle: NG

### Position correction

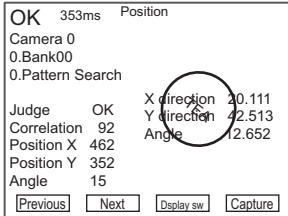

The position correction result is displayed.

### Variables list

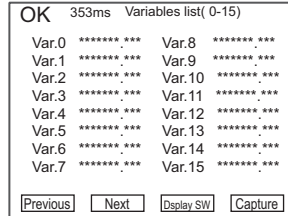

The variable results are displayed as a list.

### Data list

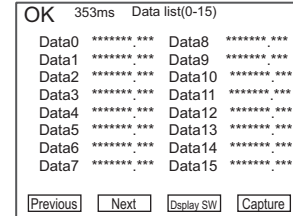

The data results are displayed as a list.

### Judgments list

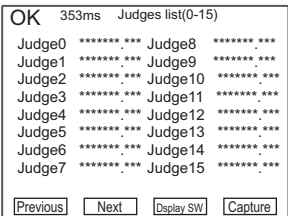

The judgment results are displayed as a list.

### Logging monitor

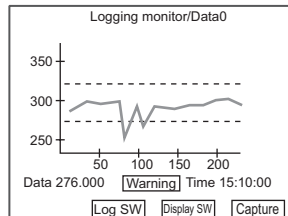

Measurement results are logged, and the log is displayed as a graph.

### Statistical data

Maximum	462	Count	100
Minimum	370	NG Count	5
Average	423	NG Rate	5%
Deviation	210	Alarm Cou	20

Navigation buttons 'Log SW', 'Display SW', and 'Capture' are at the bottom.

The statistical values of the logged data are displayed.

### Important

Logging data and statistical data are erased from memory when the Controller is turned OFF.

- To reset the log without turning the Controller OFF p.114
- To save logging data on the SD card p.140

### Note

Input the trigger using the SET and UP keys.

## Menu Buttons

Select the menu buttons displayed on the LCD screen by the touch pen or function keys. The functions that are assigned to buttons differ according to the screen.

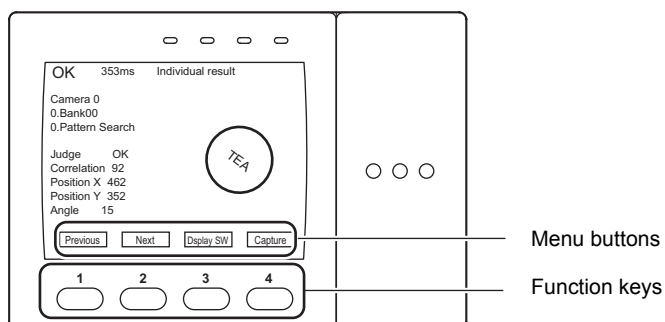

Screen	F1	F2	F3	F4
Individual results	Previous	Next	Display switch (sw)	Capture
All results/Region	-	Camera switch (sw)	Display switch (sw)	Capture
All results/Judge	-	-	Display switch (sw)	Capture
Position correction	Previous	Next	Display switch (sw)	Capture
Variables list	Previous	Next	Display switch (sw)	Capture
Data list	Previous	Next	Display switch (sw)	Capture
Judgment list	Previous	Next	Display switch (sw)	Capture
Logging monitor	-	Log switch (sw)	Display switch (sw)	Capture
Statistical data	-	Log switch (sw)	Display switch (sw)	Capture

### Menu button functions

Function Name	Description
Previous	Individual results/Position correction: The previous measurement item results are displayed. Variables/Data/Judgment list: The previous page is displayed.
Next	Individual results/Position correction: The next measurement item results are displayed. Variables/Data/Judgment list: The next page is displayed.
Camera switch (sw)	Switches the camera to be displayed.
Log switch (sw)	Logging monitor: Switches the parameters to be displayed. Statistical data: Displays the statistical data of the assigned setting value.
Display switch (sw)	Switches the content of the measurement information that is displayed.
Capture	Captures the display screen and saves it on SD card.

## How Items Are Displayed on the Logging Monitor

The trends of three parameters can be monitored in the logging monitor.

By displaying the minimum and maximum values, whether or not an NG has occurred can be checked and judged in real time.

Up to 10,000 items of data can be logged, and the logging monitor data is held in memory until the Controller is turned OFF.

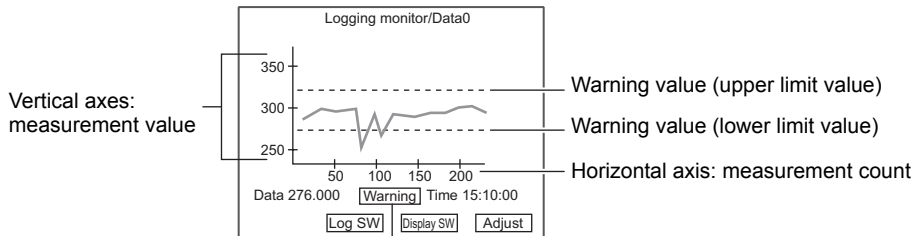

The warning is displayed when the measurement result falls below or exceeds the warning value.

Adjusting the scale of the horizontal and vertical axes p.123

## Switching the Image Display Method

In the Individual results display or Position correction display, you can hide or reduce the size of images that are displayed simultaneously with measurement information. Each press of the  $\uparrow$  UP key/ $\downarrow$  DOWN key switches the image display as follows:

Full display

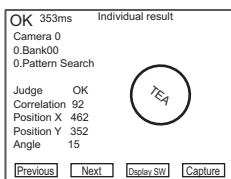

1/4 display

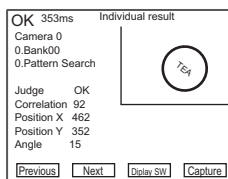

No image

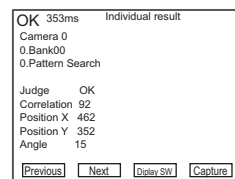

The 1/4 display is available only for the individual results display and position correction display.

In the "Variables list," "Data list" or "Judgments list" display, each press of the  $\uparrow$  UP key/ $\downarrow$  DOWN key toggles display/hide of the camera image.

No image

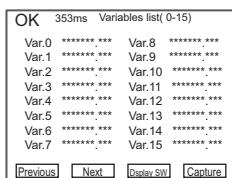
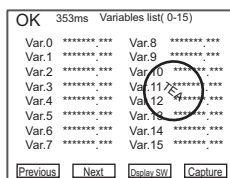

Image display





# Checking/Adjusting the Measurement - ADJ Mode

## Checking Measurement Status

Display the image currently being measured and measurement results on the LCD screen while performing continuous measurement. (In the ADJ mode, trigger input is not accepted.) The currently saved measurement data can also be checked using the logging monitor and statistical data. Saved images can also be displayed. To switch the screen display, either select [Display SW] or press the F3 key.

### Individual results

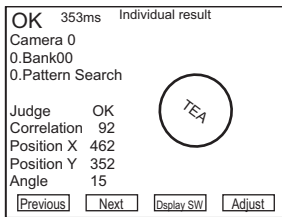

Results are displayed individually for each measurement item.

### All results/Region

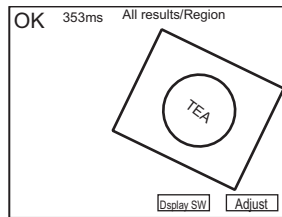

The entire measurement region is displayed.

### All results/Judge

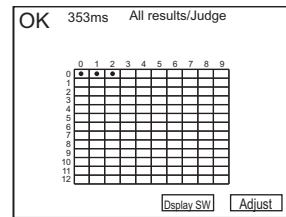

All measurement results are displayed as a list.

Horizontal axis: Smallest digit of item No.  
Vertical axis: Upper two digits of item No.  
Green circle: OK  
Red circle: NG

### Position correction

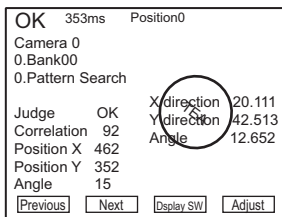

The position correction result is displayed.

### Variables list

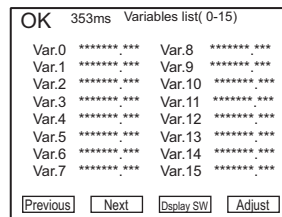

The variable results are displayed as a list.

### Data list

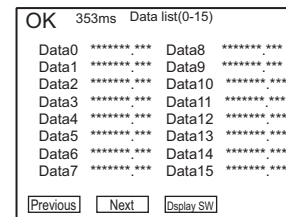

The data results are displayed as a list.

### Judgments list

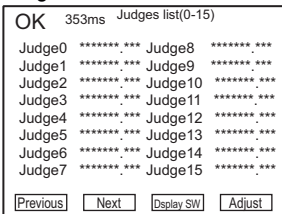

The judgment results are displayed as a list.

### Stored image

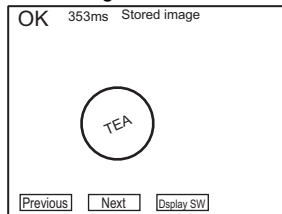

Saved images are displayed.

### Logging monitor

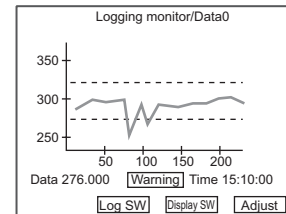

Conditions can be adjusted while viewing the measurement results saved to the logging monitor.

### Statistical data

Statistical data/Data0			
Maximum	462	Count	100
Minimum	370	NG Count	5
Average	423	NG Rate	5%
Deviation	210	Alarm Cou	20

[Log SW] [Display SW]

The statistical data saved to the logging monitor is displayed.

## Menu Buttons

Select the menu buttons displayed on the LCD screen by the touch pen or function keys. The functions that are assigned to buttons differ according to the screen.

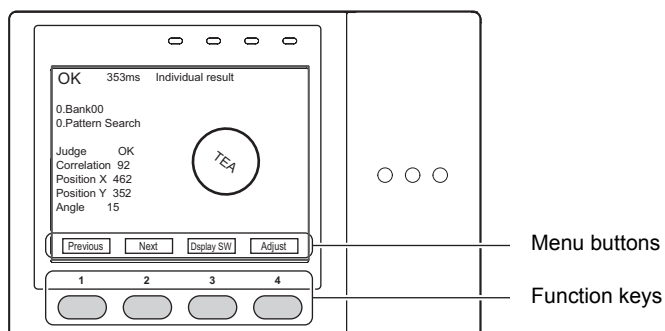

Screen	F1	F2	F3	F4
Individual results	Previous	Next	Display switch (sw)	Adjust
All results/Region	-	Camera switch (sw)	Display switch (sw)	Adjust
All results/Judge	-	-	Display switch (sw)	Adjust
Position correction	Previous	Next	Display switch (sw)	Adjust
Variables list	Previous	Next	Display switch (sw)	Adjust
Data list	Previous	Next	Display switch (sw)	-
Judgments list	Previous	Next	Display switch (sw)	Adjust
Stored image	Previous	Next	Display switch (sw)	-
Logging monitor	-	Log switch (sw)	Display switch (sw)	Adjust
Statistical data	-	Log switch (sw)	Display switch (sw)	-

### Menu button functions

Function Name	Description
Previous	Individual results/Position correction: The previous measurement item results are displayed. Variables/Data/Judgment list: The previous page is displayed. Saved image: The previous saved image is displayed.
Next	Individual results/Position correction: The next measurement item results are displayed. Variables/Data/Judgment list: The next page is displayed. Saved image: The next saved image is displayed.
Camera switch (sw)	Switches the camera.
Log switch (sw)	Logging monitor: Switches the parameters to be displayed. Statistical data: Displays the statistical data of the assigned setting value.
Display switch (sw)	Switches the content of the measurement information that is displayed.
Adjust	Adjusts the measurement items related parameters.

#### Note Capture function

In the ADJ mode, the capture function is assigned to the AUTO key.

# Switching the Image Display Method

In the Individual results display or Position correction display, you can hide or reduce the size of images that are displayed simultaneously with measurement information. Each press of the ↑ UP key/↓ DOWN key switches the image display as follows:

In the Stored image display, the image display is switched between 1/4 display and full display.

Full display

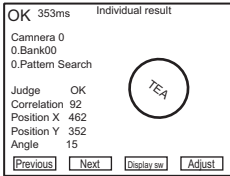

1/4 display

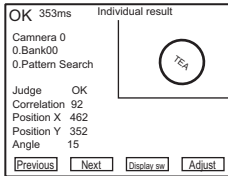

No image

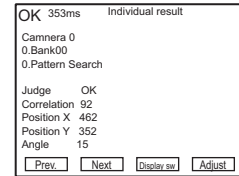

The 1/4 display is available only for the individual results display and position correction display.

The image is not displayed while a saved image is displayed.

In the "Variables list," "Data list" or "Judgments list" display, each press of the ↑ UP key/↓ DOWN key toggles display/hide of the camera image.

No image

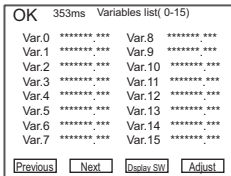
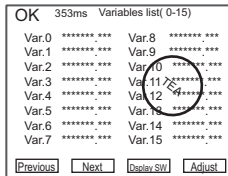

Image display



# Using a Saved Image to Perform Re-measurement

Re-measurement can be performed using a measurement image saved in the RUN mode. If the ← L key/→ R key is pressed in the Individual results display or All results/Region display, the screen switches to the saved image and re-measurement is executed.

**Note**

Up to 100 images can be saved. Images that were judged as NG also can be saved.



Measurement Image Save Conditions, p.137

# Adjusting Measurement Conditions

If you switch to the adjustment mode screen, the ADJ mode is still active and you can adjust measurement conditions.

## Adjusting Measurement Item Conditions

Adjusting conditions while monitoring the live image

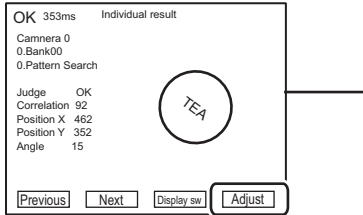

Adjusting conditions while monitoring a saved image

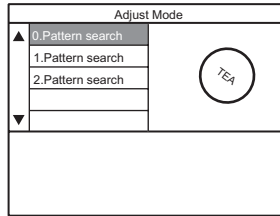
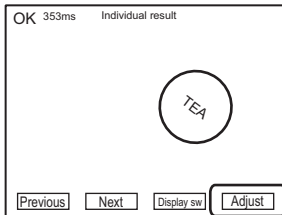

Select the target item.

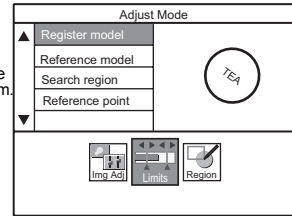

- Adjusting the measurement region
- Adjusting the image (other than "Select camera")
- Adjusting the threshold value

## Adjusting Logging Monitor Conditions

The logging monitor has the following three adjustment items.

Item	Description
Warning level	In addition to a judgment threshold, warning levels can be set so that a warning is displayed when the measurement result falls below or exceeds the warning value. Displaying "Warning" before NGs frequently occur enables feedback to pre-processes.
Display range (vertical axis)	The scale of the horizontal and vertical axes can be changed to make the graph easier-to-view.
Number of display results (horizontal axis)	

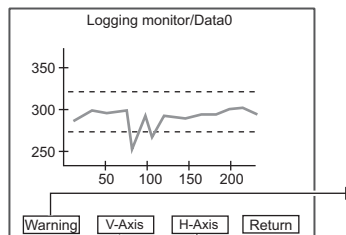
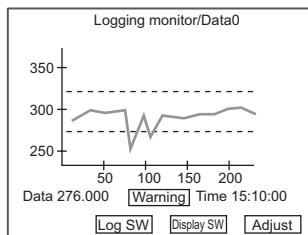

**Warning level**  
Specify the warning level by vertically dragging the bar or by directly entering numerical values.

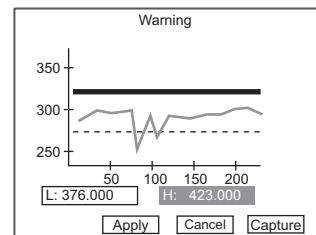

**Display range (vertical axis)**  
Specify the center value and scale width using numerical values.

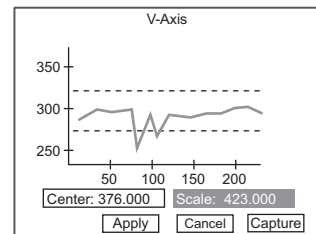

**Number of display results (horizontal axis)**  
Select from the currently displayed options.

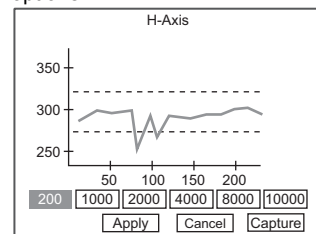

MEMO

# ADDITIONAL FUNCTIONS

---

<b>Bank Settings</b>	<b>126</b>
Bank Data Operations	127
Bank Group Operations	127
<b>System Settings</b>	<b>128</b>
Camera Specifications	128
Communication Setup	128
Output Settings	132
Display Settings	134
Operation Settings	135
Measurement Control Conditions	137
Operation Conditions during Startup	138
Setting/Changing the Display Language	138
Setting/Changing the Date	139
Clearing Saved Images	139
<b>Tools</b>	<b>140</b>
Saving/Loading Data	140
SD Card Operations	141
Checking Density Distribution (Profile)	141
Checking the Communication Status with External Devices	142
Displaying the Controller Information	143

# Bank Settings

The ZFX-C can hold up to 32 sets of settings, which are called a "bank," in internal memory. Bank 0 is displayed as the default bank when the Controller is turned ON. Banks 1 to 31 are also provided in addition to this. The device setup can be changed easily by just switching banks if banks are registered to suit specific conditions and content.

## Note

The number of banks can be increased to 1024 by attaching an SD card (capacity: 256MB). 32 banks are handled as a single group, and up to 32 groups can be set. In other words, this means that 32 bank groups are the same as having set 1024 banks.

In this case, bank group 0 is saved on the Controller's internal flash memory, and bank groups 1 to 31 are saved on the attached SD card.

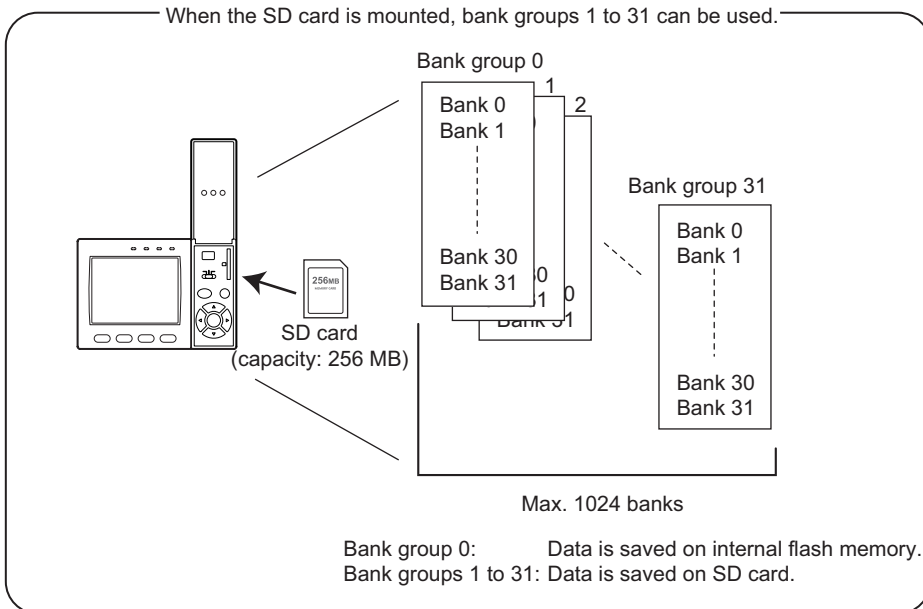
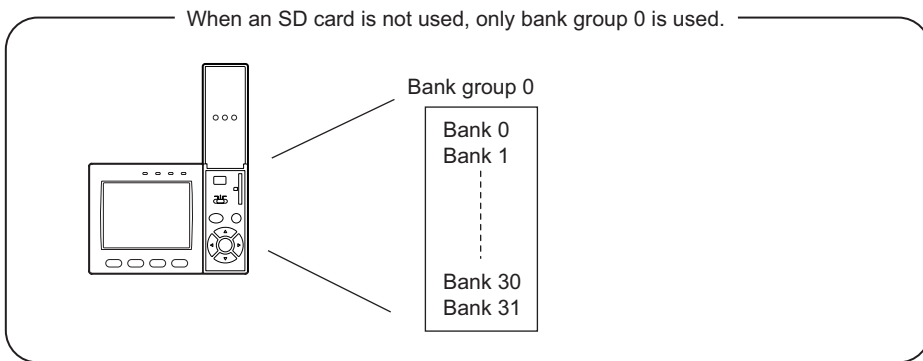



# Bank Data Operations

The following operations can be performed on bank data.

## ► MENU mode - [Bank] - [Bank]

Setup Item	Description
Switch	Switches the currently selected bank to other banks. Switching of banks can also be instructed by operating the keys on the Controller, or by issuing external signals or serial communication commands. Range: 0 to 31
Copy	Copies already created bank data to other banks. Select [Copy] and the copy destination bank after displaying the copy source No. (default value: Bank0)  <b>Important</b> Be sure to save bank data after copying a bank. Data is cleared when the Controller is turned OFF after you just copy the data.
Rename	Specified bank No. can be renamed with any name. (within 16 characters)
Erase	Deletes specified bank data.

# Bank Group Operations

When the bank group is switched to any group other than 0 and saved, the directory "BANKGRP" is automatically created on the SD card. The data of bank groups is saved to this directory using file names BGR\_0001.BNG to BGR\_0031.BNG.

### Important

When setup data has been changed, save the setup data before switching the bank group. Otherwise, the newly changed setup data is cleared. To automatically save setup data when a bank group is switched, set [Save at switch BG] to ON.

 Saving during Switching of Bank Groups p.136

## ► MENU mode - [Bank] - [Bank Group]

Setup Item	Description
Switch	Switches the bank group with the SD card attached. After the bank group is switched, select the target bank No. Range: 0 to 31

### Note

Copy/erase/rename can be executed on bank groups also.

# System Settings

## Camera Specifications

Set the basic conditions of the camera connected to the Controller.

### ► MENU mode - [System] - [Camera] - [Camera 0/1]

Setup Item	Description
White balance	The environment or lighting around the camera sometimes makes images captured from the camera look as if they are color-tinted even if the image is of a white measurement target. The function for correcting the color so that white objects are reproduced correctly in white on screen is called "white balance." Automatically adjusts the white balance while displaying white paper or cloth on screen. This function can be set only when a color camera is connected to the Controller.
Strobe delay time	Set the delay time from input of the TRIG signal up to output of the STGOUT signal. Range: 0 to 60000 $\mu$ s
Strobe polarity	Sets the output polarity of the STGOUT signal. Range: Positive/Negative  <Positive when signal is in PNP type>      <Negative when signal is in PNP type> <Negative when signal is in NPN type>      <Positive when signal is in NPN type>    When strobe polarity is set to "Negative", a delay of about 50 to 100 $\mu$ s occurs from input of the TRIG signal until the STGOUT signal turns Low. When a high-speed shutter is used, use the Controller with the strobe polarity set to "Positive".
Strobe width	Sets the time that the STGOUT signal is output. Range: 0 to 60000 $\mu$ s
Trigger delay time	Adjusts the time from input of the TRIG signal until the camera's shutter opens. Adjust this time, for example, to prevent mutual interference. Range: 0 to 60000 $\mu$ s

## Communication Setup

Set the communication specifications for the Controller matched to the communication specifications of external devices.

### Serial Communication

#### RS-232C/422

Set the basic communication specifications for when communications is performed with external devices on the serial interface. Set the communication specifications to match those of the external devices.

### ► MENU mode - [System] - [Comm] - [RS-232C/422]

Setup Item	Setting value
Interface	RS-232C (default value), RS-422
Baud rate	9600, 19200, 38400 (default value), 57600, 115200
Data length	7 bit, 8 bits (default value)
Parity	None (default value), Even, Odd

Setup Item	Setting value
Stop bits	1 bit (default value), 2 bits

## Normal

Set the conditions required for performing serial communications in the normal mode.

### ► MENU mode - [System] - [Comm] - [Normal]

Setup Item	Setting value
Delimiter	CR (default value), LF, CR+LF

## Parallel Communication

### Parallel communication

Set the conditions required for performing parallel communications.

### ► MENU mode - [System] - [Comm] - [Parallel]

Setup Item	Description
Polarity	Sets the ON condition when the judgment result is output to the DO0 to DO15 and OR signals. NG: ON: Signals turn ON when the judgment is NG. (default value) OK: ON: Signals turn ON when the judgment is OK.
Output cycle	Sets the output cycle for the measurement results. Set a time that is "Gate ON delay + Gate ON time" or more and that is shorter than the measurement cycle. Range: 2.0 to 10000.0 ms (default value: 10.0 ms)
Gate ON delay	Sets the time from output of the measurement result to the DO0 to 15 signals until the GATE signal turns ON. This is the time to wait until stable output data can be obtained. Set a value longer than the ON delay/OFF delay time of the external device. Range: 1.0 to 1000.0 ms (default value: 0.0 ms)
Gate ON time	Sets the time that the GATE signal is ON. Set a value that allows the external device to capture the measurement result. Range: 1.0 to 1000.0 ms (default value: 5.0 ms)
Handshaking	Sets the output method for the measurement results. OFF: Measurement results are output asynchronously with external devices. (default value) ON: Measurement results are output synchronously with external devices.
Timeout	Sets the time until the timeout error is output. A timeout error occurs when there is no response from the external device within the preset time. Range: 1.0 to 60.0 s (default value: 10.0 s)

## OR signal

Set the output conditions of the OR signal.

### ► MENU mode - [System] - [Comm] - [OR output]

Setup Item	Description
Output mode	Sets the output conditions of the OR signal. One-shot: The OR signal turns ON for the specified time only when the ON condition (Polarity) is satisfied. The OR signal turns OFF when the specified time has elapsed. Level: The ON/OFF status is held until it next changes after the OR signal has been output. (default value)
Output time	Sets the time that the OR signal is output as a one-shot signal. Range: 0 to 255 ms (default value: 0 ms)

## ENABLE signal ON range

Set the timing during measurement processing that the ENABLE signal is turned ON.

### ► MENU mode - [System] - [Comm] - [ENABLE range] - [Range]

Setting value	Description
Input image	Turns the ENABLE signal ON when image input is complete. This serves as a guideline as to whether it is OK or not to move the measurement target. <div style="text-align: center;"> </div> <p><b>Important</b></p> <p>When [Input image] is selected, do not input the next command until measurement is complete even if the ENABLE signal is ON. If the next command is input, the measurement currently being executed or the input command will not be executed normally.</p>
Measurement	Turns the ENABLE signal ON when measurement is complete. (default value) <div style="text-align: center;"> </div>
Display	Turns the ENABLE signal ON when display of the measurement result is complete. Processing until end of display is processed as "measurement in progress." <div style="text-align: center;"> </div>

## ENABLE reverse

Set whether or not to reverse the ON/OFF state of the ENABLE signal.

### ► MENU mode - [System] - [Comm] - [ENABLE output] - [Reverse]

Setting value	Description
OFF	The ON/OFF state of the ENABLE signal is not reversed. (default value)
ON	The ON/OFF state of the ENABLE signal is reversed. The ENABLE signal turns ON during processing by the ZFX. The ENABLE signal can be used as a signal for indicating that the ZFX-C is executing processing.

## Ethernet Communication

Set the communications specifications for performing communications with external devices on an Ethernet connection.

### ► MENU mode - [System] - [Comm] - [Ethernet]

Setting value	Description
Connection	Sets whether to enable or disable Ethernet communications. ON: Ethernet communications is enabled. (default value) OFF: Ethernet communications is disabled. This shortens the measurement time.
IP address	Sets the same address (excluding the rightmost address) as the PC that the ZFX-C is connected to. Set a unique address as the rightmost address. Do not set the same address twice in the network. (0.0.0.0 to 255.255.255.255, default value: 192.168.0.250)
Subnet mask	Sets the same subnet mask as the PC that the ZFX-C is connected to. (0.0.0.0 to 255.255.255.255, default value: 255.255.255.0)

#### Important

- Before connecting to an existing LAN, consult with the network administrator to confirm the network settings. If wrong settings are set, the ZFX-C and other devices on the network might no longer function properly.
- The ZFX-C cannot be controlled simultaneously from multiple PCs on the network.
- The network state sometimes causes a delay in data communications with the ZFX-C. If a fast response is required, we recommend performing data communications over a parallel I/O interface.
- The firewall functions of the PC that the ZFX-C is connected to might disturb data communications with the ZFX-C. In this case, disable the firewall on the PC.

# Output Settings

Set the output destination for the measurement results and the various conditions required according to the output destination.

## Output Destination

Set the items that are output as the measurement result and their output destinations. The ZFX-C can output two items, "data" and "judgment," as measurement results.

### Data output destination

Set the items that are output as the measurement result and their output destinations.

#### ▶ MENU mode - [System] - [Output] - [Data output]

Setup Item	Description
RS-232C/422	Selects ON to output data on the RS-232C/422 interface. (default value: OFF)
Parallel	Selects ON to output data via the parallel port. (default value: OFF)
SD card	Selects ON to output data to the SD card. (default value: OFF)
USB	Selects ON to output data via the USB port. (default value: OFF)
Ethernet	Selects [ON] to output data on an Ethernet connection. (default value: OFF)

### Judgment output destination

Set the output destination when judgments are to be output as the measurement results.

#### ▶ MENU mode - [System] - [Output] - [Judgement output]

Setup Item	Description
Parallel	Selects ON to output judgments via the parallel port. (default value: OFF)

### Overall Judgment Output

Set whether or not to output the overall judgment.

#### ▶ MENU mode-[System]-[Output]-[Total jg. output]

Setup Item	Description
Parallel	Selects [OFF] to disable overall judgment on the OR signal of the parallel port. (default value: ON)



## Binary format

When outputting measurement values in binary format, set the following items. Setup of other items is not required as they are for ASCII format.

### ► MENU mode - [System] - [Output] - [Date format (Serial)/(SD Card)]

Setup Item	Description
Output form	Selects binary.
Display at time	Prefixes the output data with time information. Range: OFF (default value), ON
File name	Sets the name of the output file. (only when SD card is selected)

### Note Output format

The value obtained by multiplying the measurement value by 1000 times is output continuously as 4 bytes per single data item. Minus numbers are output as 2's complement.

<Measurement value of data 0 x 1000> <Measurement value of data 1 x 1000> ... <Measurement value of data 31 x 1000>  
└──────────────────┘ └──────────────────┘ └──────────────────┘  
4 bytes 4 bytes 4 bytes

Example: When data 0 is "256.324" and data 1 is "-1.000"

\$00	\$03	\$E9	\$44	\$FF	\$FF	\$FC	\$18
------	------	------	------	------	------	------	------

  
└──────────┘ └──────────┘  
Data 0: 256324      Data 1: -1000  
(256.324 x 1000)      (-1.000 x 1000)

When Display at time is set to "ON", the data is prefixed with the time information.

<Year/month/day/hours/minutes/seconds><Measurement value of data 0 x 1000><Measurement value of data 1 x 1000>...<Measurement value of data 31 x 1000>  
└──────────────────┘  
6 bytes  
↑  
Year, month, day, hours, minutes, and seconds are assigned to each byte.

## Display Settings

Set the Controller's display conditions.

### ECO Display

The ZFX-C has an ECO mode display function for darkening the LCD screen to suppress current consumption when control keys or menu buttons are not operated for three minutes or more. Set this item to ON to enable the ECO mode display function.

The ECO display setting is enabled only in the RUN mode.

### ► MENU mode - [System] - [Display] - [Eco mode]

Setting value	Description
ON	Enables the ECO mode display function. (default value)
OFF	Disables the ECO mode display function.



# Operation Settings

Set and change operation-related functions.

## Display Capture

This function captures the content displayed on the LCD screen and saves it on SD card.

### Note

It takes several seconds to capture displays, during which measurement cannot be executed. To prevent the inability to perform measurement due to erroneous operation, set this function to OFF.

### ► MENU mode - [System] - [Operation] - [Display capture]

Setting value	Description
OFF	Disables the display capture function. (default value)
ON	Enables the display capture function.

### Executing display capture

Displays can be captured when [Capture] is displayed on the LCD screen. Select either the F4 function key or [Capture] on the LCD screen.

### File names

When display capture is executed, the directory "CAPTURE" is automatically created at the root directory on the SD card, and an image file of the currently displayed screen is stored to the CAPTURE directory.

The format of file names is "CAPT\*\*\*.BMP". A running number starting from 000 is automatically assigned to "\*\*\*\*".

## Saving during Switching of Bank Groups

Set whether or not to save setup data when a bank group is switched. If saving of setup data is disabled, the total time taken to switch bank groups can be shortened.

### Important

When setup data is changed at the default setting (saving of setup data set to OFF), be sure to manually save the data before you switch bank groups. Otherwise, the newly changed setup data is cleared.

 Saving Setup Data p.36

### ► MENU mode - [System] - [Operation] - [Save at Switch BG]

Setting value	Description
ON	Saves setup data when a bank group is switched.
OFF	Does not save setup data when a bank group is switched. (default value)

## Password

You can set a password for enabling switching to other modes to prevent erroneous operation.

### Note

If you have forgotten your password, you can confirm it by entering the PASSWORD command via the serial interface.

 Serial Communication Command Reference

### ► MENU mode - [System] - [Operation] - [Password] - [MENU/ADJ/RUN mode]

Setting value	Description
OFF	No password is set for moving to other modes. (default value)
ON	A password must be input to switch to other modes.

### ► MENU mode - [System] - [Operation] - [Password]

Setting value	Description
Password settings	Sets the password.

## Key Lock in RUN Mode

Menu buttons and operation of the touch panel in the RUN mode can be locked to prevent erroneous operation. Note, however, that mode switching is not locked.

### ► MENU mode - [System] - [Operation] - [RUN mode key lock]

Setting value	Description
OFF	The key lock is disabled. (default value)
ON	The key lock is enabled.

# Measurement Control Conditions

Set and change measurement processing-related functions.

## Measurement Image Save Conditions

Sets the conditions for saving measurement images.

**Note** Saving measurement images

Up to 100 images can be saved. When the number of saved images exceeds 100, new images are saved by overwriting the oldest image. Up to 50 images are saved to one camera when two cameras are connected. When the Controller is turned OFF, images saved on the Controller are cleared. Saved images only can also be cleared without turning the Controller OFF.

 p.139

► MENU mode - [System] - [Measure] - [Image storage]

Setting value	Description
None	Measurement images are not saved. (default value)
Only NG	Measurement images are saved only when the measurement result is NG.
All	All measurement images are saved regardless of the measurement result.

## Saved Image Delete Conditions

Sets the conditions for clearing saved images.

► MENU mode - [System] - [Measure] - [Image deletion]

Setting value	Description
At bank switch	Clears saved image at bank switching. (default value)
OFF	Disables clearing of saved image at bank switching.

## Handling the ENABLE Signal

Set how the ENABLE signal is handled.

### Note ENABLE signal

The ENABLE signal is a control signal for indicating that the ZFX-C is ready to accept a measurement trigger or a command from an external device. External devices monitor the ON/OFF timing of this ENABLE signal to input the measurement trigger or commands to the ZFX.

## Operation when the TRIG signal is input during measurement

Next measurement is not executed even if the TRIG signal from an external device is input during measurement. Set whether or not to notify an external device that TRIG signal input was not accepted.

### ► MENU mode - [System] - [Measure] - [Trig in measure]

Setting value	Description
OFF	The ERR signal does not turn ON even if the TRIG signal turns ON during measurement.
ERR ON	The ERR signal turns ON when the TRIG signal turns ON during measurement. (default value) The ERR signal turns OFF when the next TRIG signal is input at the correct timing.

## Operation Conditions during Startup

Set the bank data to be displayed when the Controller is started up.

### ► MENU mode - [System] - [Startup]

Setup Item	Description
Startup Bank Group	Sets the bank group No. to be displayed when the Controller is started up. (default value: 0) When bank groups 1 to 31 are selected, start up the Controller with the SD card containing the corresponding bank data attached.
Startup Bank	Sets the bank No. to be displayed when the Controller is started up. Range: 0 to 31 (default value: 0)

## Setting/Changing the Display Language

Set the display language of the LCD screen.

### ► MENU mode - [System] - [Language]

Setting value	Description
Japanese	UI text in the LCD screen and menus is displayed in Japanese.
English	UI text in the LCD screen and menus is displayed in English.

# Setting/Changing the Date

Set the date and time of the Controller's internal calendar timer.

▶ **MENU mode - [System] - [Date]**

Setup Item	Description
Year, Month, Day, Hour, Minute, Second	Set the date and time units.

# Clearing Saved Images

Measurement images saved on the Controller can be cleared without turning the Controller OFF.

▶ **MENU mode - [System] - [Init.] - [Clear stored images]**

## Saving/Loading Data

You can back up setup data and measured image data on SD cards. Alternatively, these backed up data can be loaded to the Controller.

### Data that can be saved/loaded

- System data: Setup data under [System]
- Bank data/bank group data: Setup data under [Setup]
- Image data: Measurement image data saved internally on the Controller (proprietary format: color images \*.BYR, black-and-white images \*.GRY)
- Logging data: Data accumulated by the logging monitor

#### Important

During execution of a save or a load, do not input the RESET signal or turn the power OFF. Doing so might damage the data, or prevent the Controller from functioning normally when it is next started up.

### ► MENU mode - [Tool] - [Backup]

Setup Item	Description
Image data	Select the target data to perform save/load on.
Bank data	Save: Saves the target data on the Controller to SD card. Load: Loads target data saved on SD card to the Controller.
Bank group data	
System data	<b>Important</b> Logged data can only be saved.

#### Note

### Configuration of directory/files on SD Card

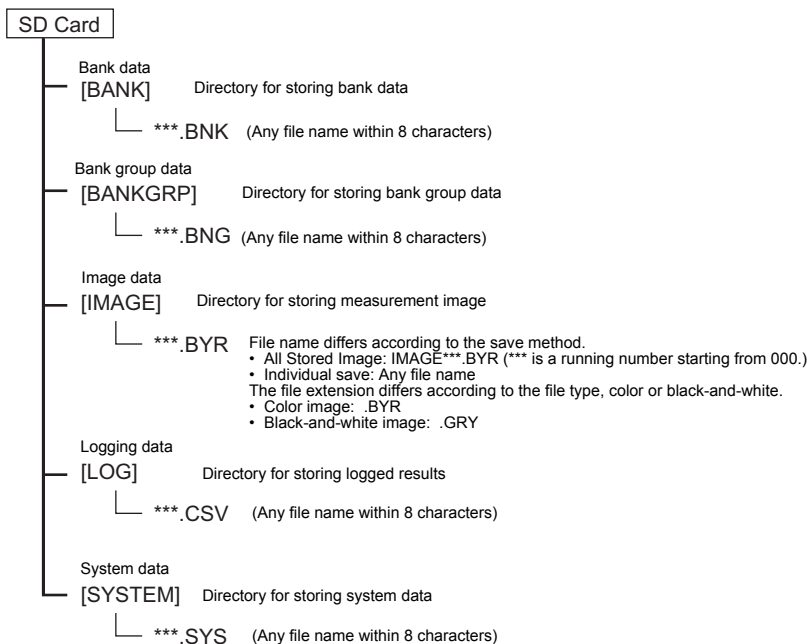

# SD Card Operations

## ► MENU mode - [Tool] - [SD card]

Setup Item	Description
File operation	Deletes or renames files, for example.

### Note

The remaining space on the SD card can be checked.

## Checking Density Distribution (Profile)

The graph indicating the density distribution of a single line in the screen is called a "profile." Profiles can be displayed for any horizontal or vertical line.

When a color camera is connected to the Controller, profiles can be displayed using a specified color filter.

## ► MENU mode - [Tool] - [Profile]

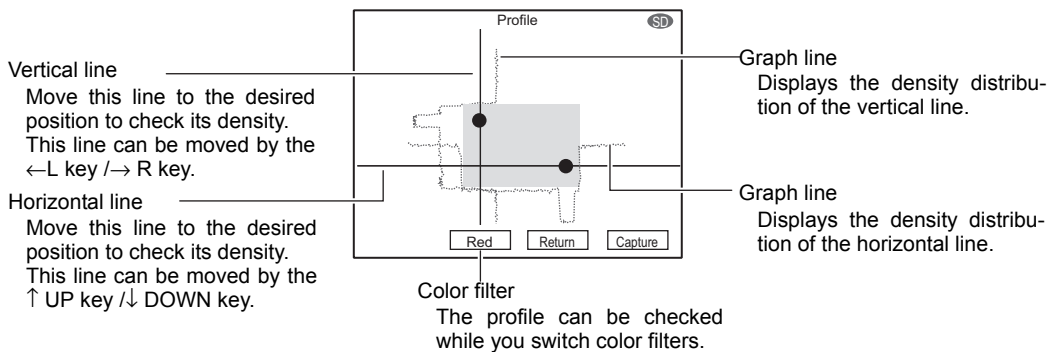

**Note** How to fully utilize the profile function

- You can check whether or not light is illuminating the measurement target evenly.

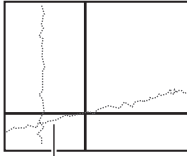

If the graph lines are inclined even though the measurement target illuminated as a uniform color on screen, you can judge that lighting is uneven.

- You can judge the extent of the density difference between the background and desired inspection location.

Example: Defect inspection

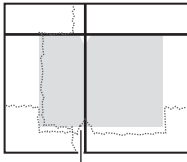

You can monitor depressions on the graph lines to the extent of density differences at certain locations.

## Checking the Communication Status with External Devices

When the Controller is connected to an external device via the RS-232C/422 interface or parallel interface, you can monitor the communication status to verify the normality of the wiring and communication setup.

### RS-232C/422 Communication

Check the communication status of the RS-232C/422 interface.

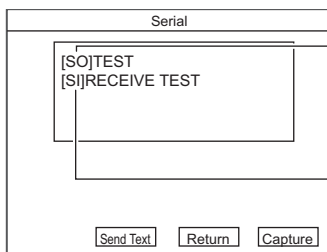

**Display [SO]**

This is the content sent to the external device. When [Send Text] is selected, a test string is sent to the external device from the ZFX. The test string can be edited.

**Display [SI]**

This is the content received from the external device. When a test string exceeding 16 characters is sent, characters from the 17th character onwards are not displayed. When the echoback setting is set to [ON], the received content is sent to the external device as it is.

### Monitor conditions

Edit the test string and echoback setting.

► **MENU mode - [Tool] - [I/O mon.] - [RS-232C/422]**

Setup Item	Description
Monitoring	The content sent to the external device and content received from the external device are displayed.
Test string	Sets the text string (maximum 16 alphanumeric characters) to be sent to the external device.



Setup Item	Description
Echoback	Sets whether or not the content received from an external device is to be returned to that device as it is. ON: The content received from an external device is sent to that device as it is. (default value) OFF: The content received from an external device is not returned.

## Parallel Communication

You can check the communication status on the parallel interface.

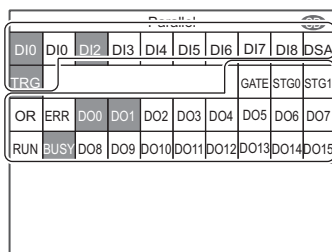

### Input signals

A reversed signal indicates that an input from an external device to the ZFX-C is ON.

### Output signals

A reversed signal indicates that an output to an external device from the ZFX-C is ON.

You can simulate turning output signals ON/OFF by selecting the signal to be tested on screen.

► MENU mode - [Tool] - [I/O mon.] - [Parallel]

## Displaying the Controller Information

Display the Controller's system information. This information allows you to check the version, memory usage, and other information.

► MENU mode - [Tool] - [Sys Info]

Setup Item	Description
Version	Displays the Controller's version.
Memory capacity	Displays the memory usage.

MEMO

# PARALLEL INTERFACE

---

<b>Connection</b>	<b>146</b>
Parallel Connector Specifications	146
<b>Internal Specifications</b>	<b>150</b>
<b>Signal I/O</b>	<b>152</b>
Input Signal	152
Output Signal	153
<b>Timing Charts</b>	<b>156</b>
Measurement (Handshaking OFF)	156
Measurement (Handshaking ON)	159
Commands Other than for Measurement	160
Signal Operation in terms of Measurement	161

# Connection

Signals such as measurement triggers can be input to the Controller, and signals such as measurement results can be output from the Controller via its parallel interface. Prepare a parallel I/O cable, and connect it to the Controller's parallel port for using the parallel interface to input commands and output measurement results.

## Parallel Connector Specifications

The Controller has two parallel ports; a standard parallel port and an extended parallel port.

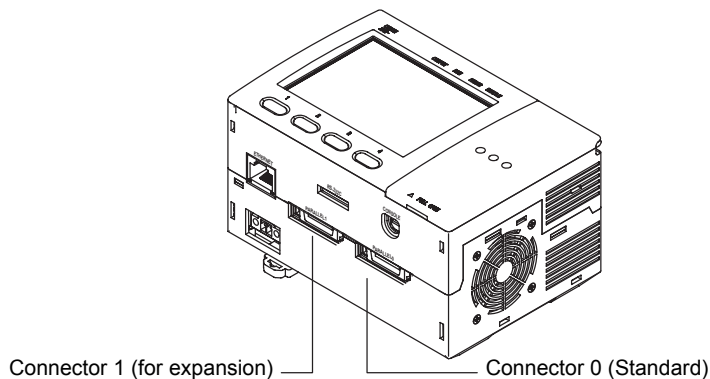

### Important

Before the Controller is turned ON, make sure that connectors 0 and 1 are wired correctly. If these connectors are wired in reverse, the cables or external devices may be damaged.

### Parallel I/O Connector 0 (Standard Parallel Port)

Wire the Terminal Block Adapter (supplied) and plug it into the Controller's parallel I/O connector 0.

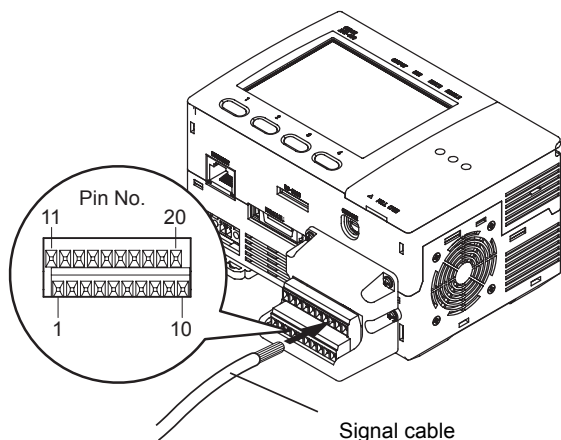

- Cable diameter: 0.14 to 1 mm<sup>2</sup>  
(AWG26 to 16 twisted lead)
- Cable length: 30 m
- Tightening torque for the respective wire:  
0.22 to 0.25 N•m
- Tightening torque for the Terminal Block Adapter:  
0.3 N•m
- Terminal block adapter mounting screws:  
M2.6 x 7 screws  
(accessories, 4 p'ces)

### Note

Instead of the Terminal Block Adapter, the parallel I/O cable (ZFX-VP) can be connected to it as well. The wiring of the parallel I/O cable is the same as that of the parallel I/O connector 1.

p.148

The pin assignment is as follows. Wire only required pins.

Pin No.	Signal name	Wire color (ZFX-VP)	Signal direction	Function
1	RESET	Brown	Input	Restarts the ZFX.
2	TRIG	Red	Input	Measurement trigger signal input
3	DI0	Orange	Input	Command parameter
4	DI1	Yellow	Input	
5	DI2	Green	Input	
6	DI3	Blue	Input	
7	DI4	Purple	Input	
8	DI5	Gray	Input	Command input
9	DI6	White	Input	
10	DI7	Black	Input	
11	DI8	Brown	Input	Parallel command confirmation signal
12	DSA	Red	Input	Data send request signal input
13	OR	Orange	Output	Overall judgment output
14	ERROR	Yellow	Output	ON when an error occurs
15	RUN	Green	Output	ON while in the RUN mode
16	ENABLE	Blue	Output	ON when measurement trigger signal can be input
17	GATE	Purple	Output	ON for the preset output time
18	DO15	Gray	Output	Data output
19	COMIN	White	-	Common for input signals, STGOUT0 and STGOUT1
20	COMOUT	Black	-	Common for OR, ERROR, RUN, ENABLE, GATE, DO15 signals

## Parallel I/O Connector 1 (Extended Parallel Port)

Hold down the two latch locks on both sides of the connector of the parallel I/O cable (ZFX-VP) to unlock the connector, and connect it to the Controller's parallel I/O connector 1. To lock the connector again, release the latch locks.

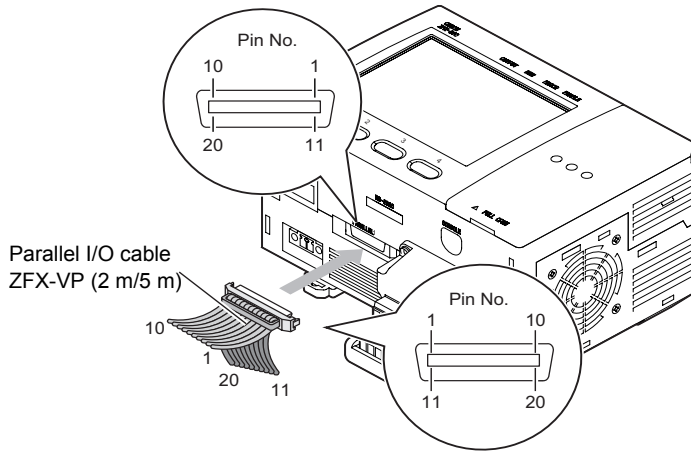

### ► Specification of a parallel I/O cable

Item	Connector	Flat cable
Manufacturer name	Hirose electric Co. Ltd.	Hitachi Cable, Ltd.
Model number	FX2B-20SA-1.27R	UL20012-ST10X28AWG
Electric wire size (thickness)	-	0.89 mm
Total cable width	-	12.70 mm
Cable length	-	2 m/5 m

Pin No.	Signal name	Wire color (ZFX-VP)	Signal direction	Function
1	STGOUT0	Brown	Output	Strobe trigger 0 output
2	STGOUT1	Red	Output	Strobe trigger 1 output
3	DO0	Orange	Output	Data output
4	DO1	Yellow	Output	
5	DO2	Green	Output	
6	DO3	Blue	Output	
7	DO4	Purple	Output	
8	DO5	Gray	Output	
9	DO6	White	Output	
10	DO7	Black	Output	
11	DO8	Brown	Output	
12	DO9	Red	Output	
13	DO10	Orange	Output	
14	DO11	Yellow	Output	
15	DO12	Green	Output	
16	DO13	Blue	Output	
17	DO14	Purple	Output	
18	COMOUT	Gray	-	Common for STGOUT0, STGOUT1, and DO0 to DO6 signals
19	(OPEN)	White	-	(Leave open.)
20	COMOUT	Black	-	Common for DO7 to DO14 signals

\*1: Use the STGOUT0 or STGOUT1 signal when you want to connect a strobe device to the ZFX.

# Internal Specifications

## Input Specifications

### ► RESET, DI0 to DI8, and DSA signals

Mode	NPN	PNP
Input voltage	12 to 24 VDC $\pm 10\%$	12 to 24 VDC $\pm 10\%$
ON current *1	5 mA min.	5 mA min.
ON voltage *1	8.8 V min.	8.8 V min.
OFF current *2	0.5 mA max.	0.5 mA max.
OFF voltage *2	1.1 V max.	1.1 V max.
ON delay	5 ms max.	5 ms max.
OFF delay	0.7 ms max.	0.7 ms max.
Internal circuit diagram		

### ► TRIG signal

Mode	NPN	PNP
Input voltage	12 to 24 VDC $\pm 10\%$	12 to 24 VDC $\pm 10\%$
ON current *1	5 mA min.	5 mA min.
ON voltage *1	8.8 V min.	8.8 V min.
OFF current *2	0.5 mA max.	0.5 mA max.
OFF voltage *2	0.8 V max.	0.8 V max.
ON delay	0.1 ms max.	0.1 ms max.
OFF delay	0.1 ms max.	0.1 ms max.
Internal circuit diagram		

\*1: The ON current/voltage is the value of the current/voltage that changes the status from OFF to ON. The value of the ON voltage is the potential difference between COM IN and each input terminal.

\*2: The OFF current/voltage is the value of the current/voltage that changes the status from ON to OFF. The value of the OFF voltage is the potential difference between COM IN and each input terminal.

\*3: The ON/OFF delay time for TRIG signal is different from the circuit diagram for RESET, DI0 to DI8, and DSA signals.



## Output Specifications

### ► OR, ERROR, RUN, ENABLE, GATE, DO0 to DO15 signals

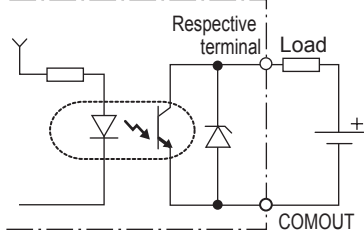
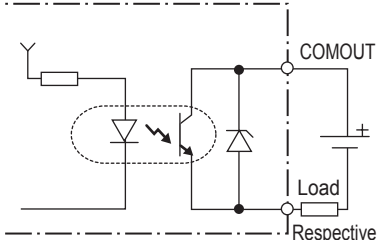
Mode	NPN	PNP
Output voltage	12 to 24 VDC $\pm 10\%$	12 to 24 VDC $\pm 10\%$
Load current	45 mA max.	45 mA max.
ON residual voltage	2 V max.	2 V max.
OFF leakage current	0.2 mA max.	0.2 mA max.
Internal circuit diagram		

### ► STGOUT 0 to 1 signals

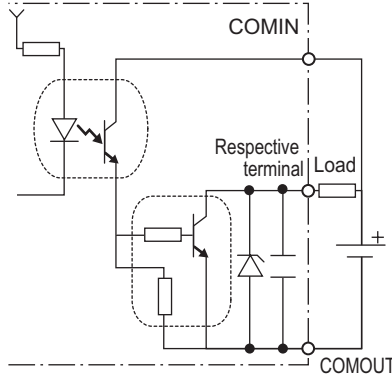
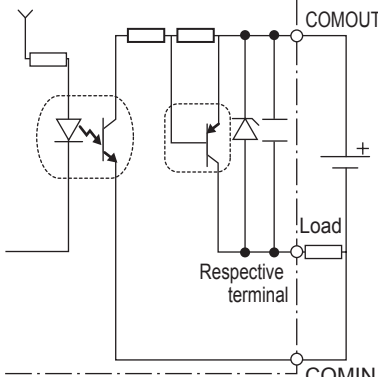
Mode	NPN	PNP
Output voltage	12 to 24 VDC $\pm 10\%$	12 to 24 VDC $\pm 10\%$
Load current	45 mA max.	45 mA max.
ON residual voltage	2 V max.	2 V max.
OFF leakage current	0.2 mA max.	0.2 mA max.
Internal circuit diagram		

#### Important

Connect a load that matches the output specifications. Otherwise, a short-circuit may occur, which will cause the Controller to break down.

# Signal I/O

## Input Signal

The following signals can be input when the ZFX-C is in the RUN mode.

### Measurement Timing Input

A one-time measurement is performed if the TRIG signal is turned ON.

### Command Input

#### Input format

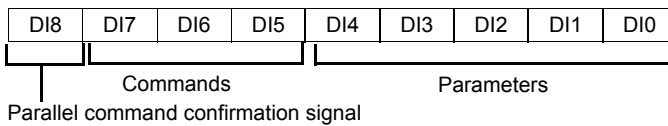

#### Commands

Signals DI0 to DI7 can input the following commands. Allow at least 5 ms after DI0 to DI7 are determined to be ON before turning DI8 ON.

#### Note

With the model re-registration setting commands, item Nos.0 to 31 can be registered. Item No.32 onwards cannot be registered by these commands. They can be registered by serial communication commands.

Command	Description	DI7	DI6	DI5	DI4	DI3	DI2	DI1	DI0
Continuous measurement	Measurements continue while the command is being input.	0	0	0	*	*	*	*	*
Bank switching	Switches the bank to measure.	0	1	0	Bank number				
Bank group switching	Switches the bank group data.	1	1	0	Bank group number				
Model re-registration	Registers the model again based on the last measurement image that was read.	1	0	0	Item number				

In the above table, a "0" indicates the signal is OFF, a "1" indicates the signal is ON. A "\*" indicates that the ZFX-C does not read the bit status, so the bit status can be either 0 or 1.

► Example

Command	Example	DI7	DI6	DI5	DI4	DI3	DI2	DI1	DI0
Bank switching	Switching to bank 2.	0	1	0	0	0	0	1	0
Bank group switching	Switching to bank group 2.	1	1	0	0	0	0	1	0
Model re-registration	Re-registering the model of item 6	1	0	0	0	0	1	1	0

## Output Signal

Measurement results are output each time a measurement is made. Measurement values and judgment results can be output as the measurement results.

Up to 32 data are output respectively (except for overall judgment result outputs.) They are output for the number of times in the expression set at “Calculation”.

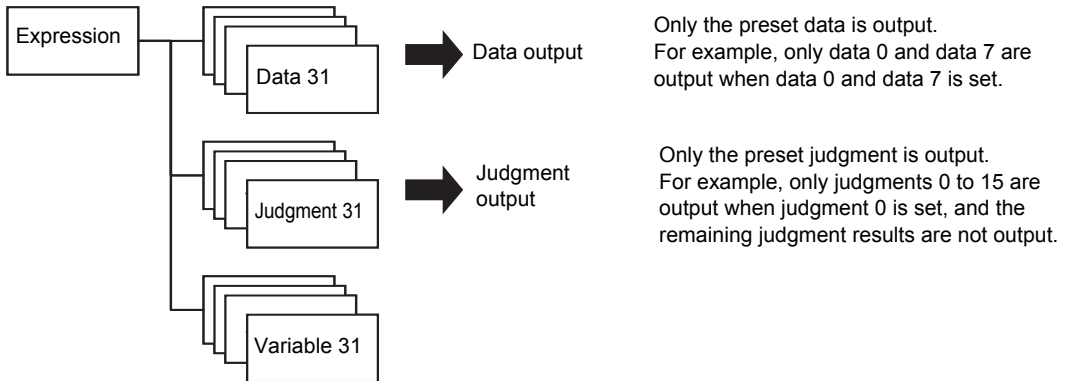

Data is output only when the ZFX-C is in the RUN mode; data is not output when the ZFX-C is in ADJ mode.

 p.109

**Note**

After measurements have been made in the RUN mode, the data that is output to the OR and DO signals is retained until new measurements are made in the RUN mode. The status of these output is retained even if the ZFX-C is switched from the RUN mode to another Mode.

## Judgment Result Output

### Overall judgment result

The ZFX-C outputs the OR signal indicating the overall judgment result. The following items can be specified whether or not to be included in the overall judgment result. The user can select whether a signal is output when the overall judgment result is OK or NG.

 Setting Reflection of Individual Results p.112

- Position correction item
- Measurement item
- Calculation (variable) result
- Calculation (judgment) result
- Logging monitor warning

### Individual judgment result

The judgment results based on the expressions that were set in the [Add func/Calculation/Judge/judge 0 to 31] are output to DO0 to DO15. The user can select whether a signal is output when the judgment result is OK or NG. The default setting is for a signal to be output when the judgment result is NG.

 Calculation p.109

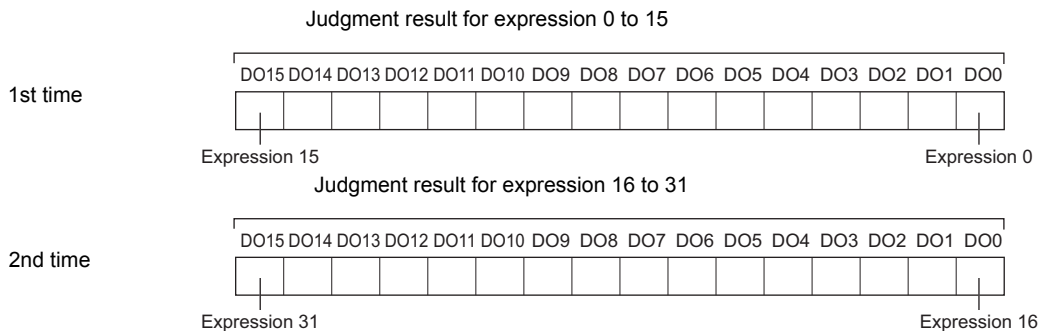

Up to 32 individual judgment results are output. No data is output when the judgment is not set in the Expression.

## Measurement Value Output

The measurement values for expressions that were set in 0 to 31 of [Add func/Calculation/Data] is output before the judgment results output, when "Parallel Output ON" was selected as the data output destination in the [System/Output/Data output] menu.

Only integer values are output. (The real values are rounded to the nearest integer.) Data is output in 2's complement format.

The measurement values for respective expressions are output in 16-bit at a time. When two or more expressions are set, 16-bit measurement values are output sequentially by the number of times equivalent to the set expressions.

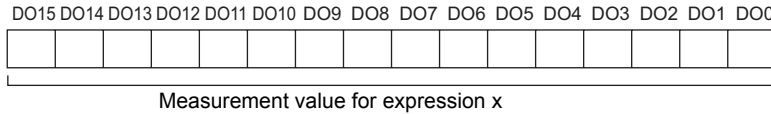

**Note**

Values in the range -32,768 to 32,767 can be output. A value of -32,768 will be output if the measurement is less than -32,768 and a value of 32,767 will be output if the measurement is greater than 32,767.

### Output example

When measurement value is "+1234"

DO15	DO14	DO13	DO12	DO11	DO10	DO9	DO8	DO7	DO6	DO5	DO4	DO3	DO2	DO1	DO0
0	0	0	0	0	1	0	0	1	1	0	1	0	0	1	0

When measurement value is "-1234"

DO15	DO14	DO13	DO12	DO11	DO10	DO9	DO8	DO7	DO6	DO5	DO4	DO3	DO2	DO1	DO0
1	1	1	1	1	0	1	1	0	0	1	0	1	1	1	0

### Output timing example

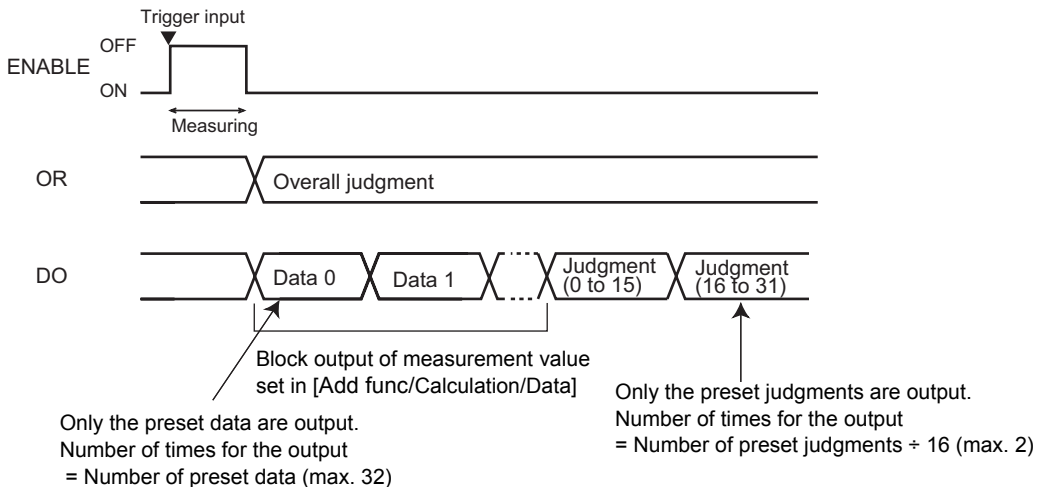

# Timing Charts

## Measurement (Handshaking OFF)

When handshaking is set to OFF, the ZFX-C outputs measurement results to the external device without synchronizing communications. Monitor the ZFX-C's GATE signal from the external device and read the measurement results at the external device while the ZFX-C's GATE signal is ON.

### Trigger Measurement

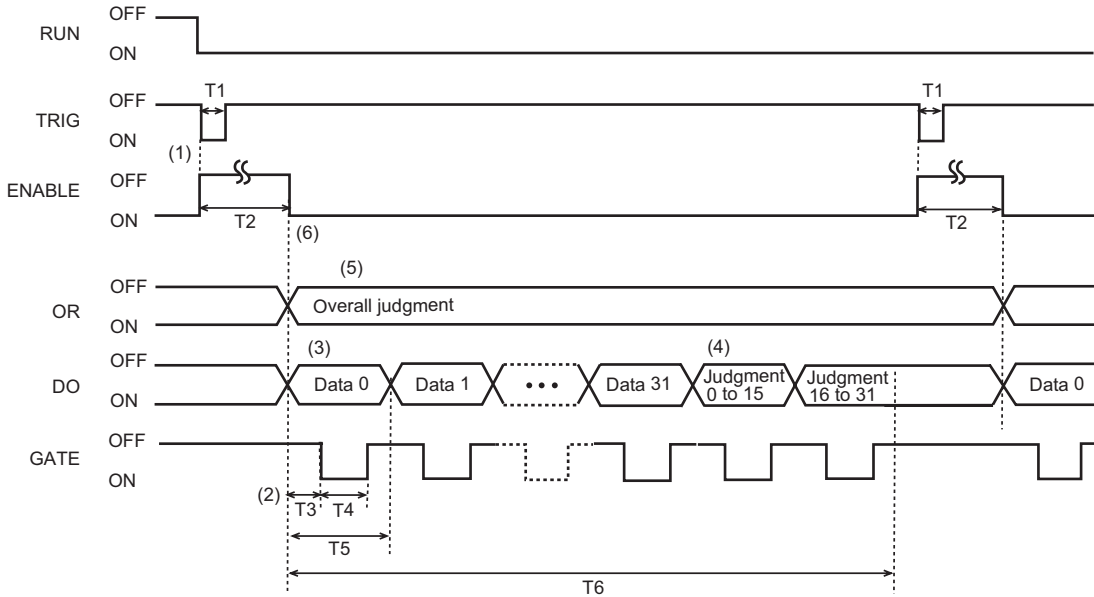

T1: Trigger input time	Set to ON for at least 0.5 ms.
T2: Measurement time	This time is "image input" + "measurement". This time can be changed to only "image input" or "image input" + "measurement" + "display".
T3: Gate ON delay	This is the time to wait until stable output data can be obtained. This time can be changed.
T4: Gate ON time	This is the time required for the external device to capture output data from the Controller. This time can be changed.
T5: Output cycle	This is the interval in which the DO signal state changes. This time can be changed.
T6: Total output time	This time is equivalent to "output cycle (T5) x number of output data items". Input the trigger at an interval longer than this time. When the total output time is longer than T2, non-output data accumulates in the Controller as the next measurement is executed before measurement results are output. When the Controller becomes filled up with this non-output data, data can no longer accumulate in the Controller. When this happens, output of non-output data continues, and the next measurement is no longer possible until queued data has finished accumulating.

► Explanation of operation

- (1) When the measurement trigger (TRIG signal) is input from the external device, measurement is executed once synchronized with the rising edge of the TRIG signal (OFF -> ON).
- (2) The GATE signal is used to control the timing at which the external device captures measurement results. Set the Gate ON delay (T3) and Gate ON time (T4) so that  $T3+T4 < T5$ .
- (3) When parallel output is set to "ON" as the data output destination, data is output for the number of times in the expression set at "Calculation (data)" (maximum 32 times). When parallel output is OFF, data is not output.
- (4) When parallel output is set to "ON" as the judgment output destination, judgment is output for the number of times in the expression set at "Calculation (judgment)" (maximum twice). When parallel output is OFF, judgment is not output.
- (5) The overall judgment is output. Overall judgment is NG if there is even one NG for the preset measurement items and judgment results in the expression. In the case of level output, the ON/OFF status of the OR signal does not change until the next output as shown in this example.
- (6) When the timing for turning the ENABLE signal ON is set to "end of image input", a delay occurs until output is started after the ENABLE signal turns ON as measurement is also executed after the ENABLE signal turns ON. Do not input the next trigger until measurement is completed.

**Continuous Measurement**

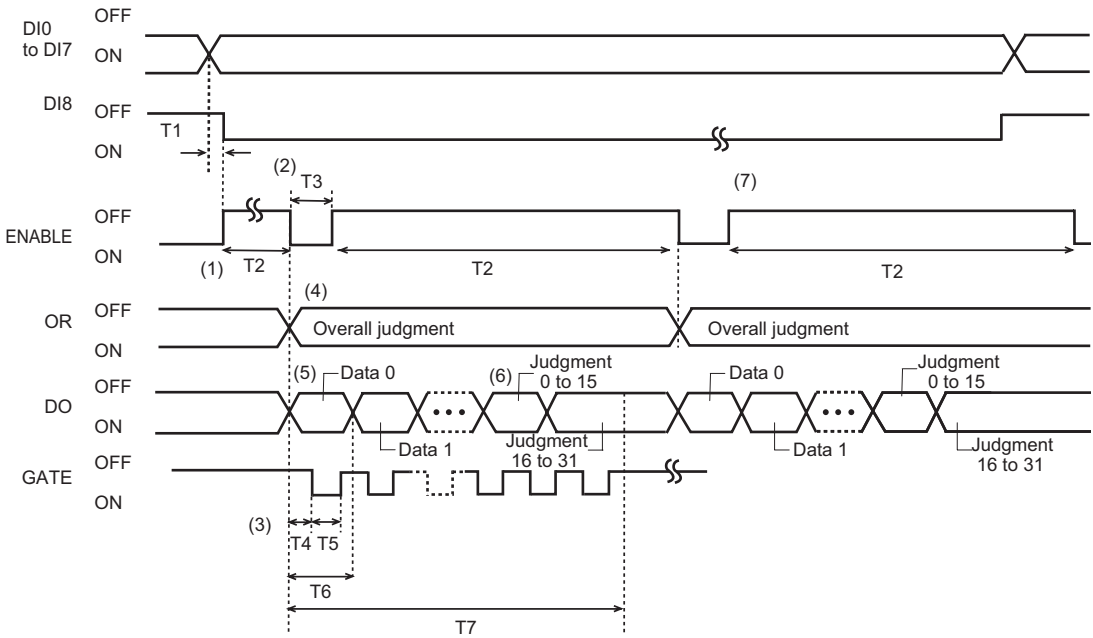

T1: Execution trigger delay time	This is the delay time until the execution trigger DI8 signal is input after commands are set to DI0 to DI7. Set a delay of at least 5 ms.
T2: Measurement time	This time is "image input" + "measurement". This time can be changed to only "image input" or "image input" + "measurement" + "display".
T3: Measurement interval time	This time changes according to the ENABLE signal conditions."

T4: Gate ON delay	This is the time to wait until stable output data can be obtained. This time can be changed.
T5: Gate ON time	This is the time required for the external device to capture output data from the Controller. This time can be changed.
T6: Output cycle	This is the interval in which the DO signal state changes. This time can be changed.
T7: Total output time	This time is equivalent to "output cycle (T6) x number of output data items". Set the total output time to be shorter than the measurement time (T2). When the total output time is longer than T2, non-output data accumulates in the Controller as the next measurement is executed before measurement results are output. When the Controller becomes filled up with this non-output data, data can no longer accumulate in the Controller. When this happens, output of non-output data continues, and the next measurement is no longer possible until queued data has finished accumulating.

### ► Explanation of operation

- (1) Continuous measurement is started synchronized with the rising edge of the DI8 signal (OFF → ON).
- (2) When the timing for turning the ENABLE signal ON is set to "end of image input", a delay occurs until output is started as measurement is also executed after the ENABLE signal turns ON. The timing of measurement result output (OR, DO) does not change even if the ENABLE signal ON timing is set to "end of image input" or "display end".
- (3) The GATE signal is used to control the timing at which the external device captures measurement results. Set the Gate ON delay (T4) and Gate ON time (T5) so that  $T4+T5 < T6$ .
- (4) The overall judgment is output. Overall judgment is NG if there is even one NG for the preset measurement regions and judgment results in the expression. In the case of level output, the ON/OFF status of the OR signal does not change until the next output as shown in this example.
- (5) When parallel output is set to "ON" as the data output destination, data is output for the number of times in the expression set at "Calculation (data)" (maximum 32 times). When parallel output is OFF, data is not output.
- (6) When parallel output is set to "ON" as the judgment output destination, judgment is output for the number of times in the expression set at "Calculation (judgment)" (maximum twice). When parallel output is OFF, judgment is not output.
- (7) If DI0 to DI7 are in the continuous measurement command execution status and DI8 is ON when measurement processing ends, the next measurement is executed. The next measurement is also executed after display processing is executed when the timing that the ENABLE signal turns ON is set to "display end." When the timing is set to other than "display end," the next measurement is executed as soon as measurement ends.



# Measurement (Handshaking ON)

When handshaking is set to ON, the ZFX-C outputs measurement results to the external device while synchronizing communications. Handshaking is effective when multiple measurement results are output in numerical order and the handshaking function transfers data with more certainty.

## Trigger Measurement

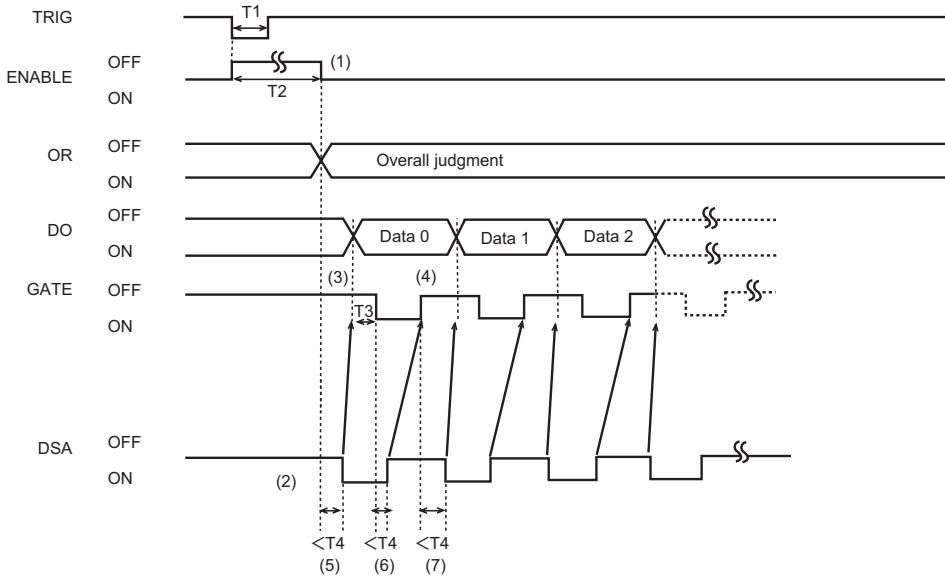

T1: Trigger input time	Set to ON for at least 0.5 ms.
T2: Measurement time	This time is "image input" + "measurement". This time can be changed to only "image input" or "image input" + "measurement" + "display".
T3: Gate ON time	This is the time to wait until stable output data can be obtained. This time can be changed.
T4: Timeout time	This is the time-out time for the following operations. <ul style="list-style-type: none"> <li>• Measurement end → DSA signal ON</li> <li>• GATE signal ON → DSA signal OFF</li> <li>• GATE signal OFF → DSA signal ON</li> </ul> The default time-out time is 10 s. This time can be changed.

### ► Explanation of operation

- (1) When measurement ends, the ENABLE signal turns ON.
- (2) The DSA signal turns ON by the external device requesting data transmission.
- (3) When the DSA signal turns ON, the DO signal is output.
- (4) When the DSA signal turns OFF, the GATE signal also turns OFF.
- (5) A time-out error occurs if the DSA signal does not turn ON during the preset time-out time after measurement ends.
- (6) A time-out error occurs if the DSA signal does not turn OFF during the preset time-out time after the GATE signal turns ON.
- (7) When multiple data items are being output for a single measurement, a time-out error occurs if the DSA signal does not turn ON with the preset time-out time after the GATE signal turns OFF.

# Commands Other than for Measurement

## Bank switching/Bank group switching/Model re-registration

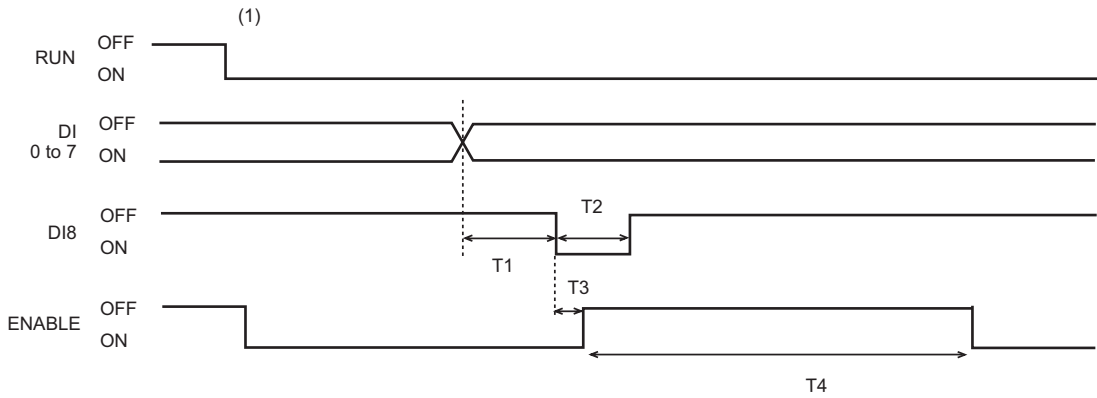

T1: Executing trigger delay time	This is the delay time until the execution trigger DI8 is input after commands are set to DI0 to DI7. 5 ms or more.
T2: Executing trigger ON time	5 ms or more
T3: Execution delay time	0.5 ms or less
T4: ENABLE OFF time	This time varies depending on settings for banks, bank groups, model registration.

### ► Explanation of operation

(1) The command input is accepted only in the RUN mode.

# Signal Operation in terms of Measurement

## Trigger Input

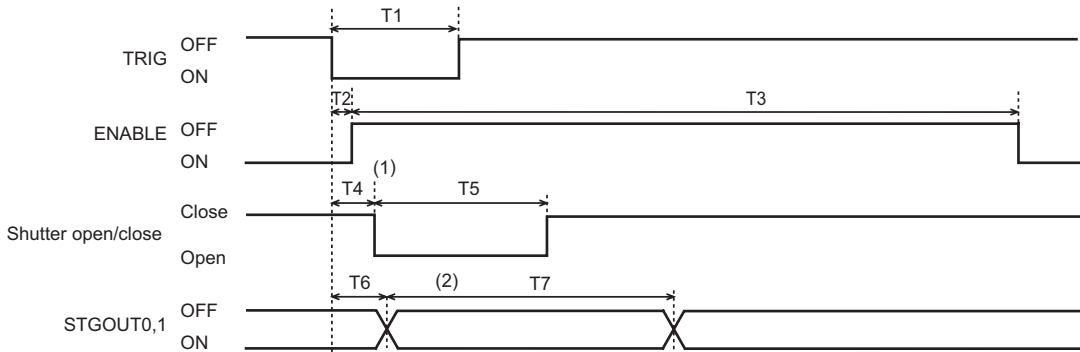

T1: Trigger input time	Set to ON for at least 0.5 ms.
T2: ENABLE output response time	This is the time after the trigger is input until the ENABLE signal turns ON. 0.5 ms or less
T3: Measurement time	This time is "image input" + "measurement". This time can be changed to only "image input" or "image input" + "measurement" + "display".
T4: Trigger delay time	This is the time after trigger input until the camera's shutter is opened (max. 65.535 ms). This time can be changed for each camera.
T5: Shutter time	This is the time that the image is captured (max. 2 ms). This time can be changed by the shutter speed setting for each camera.
T6: Strobe delay time	This is the time after trigger input until the Controller outputs the STGOUT signal (max. 65.535 ms). This time can be changed for each camera.
T7: Strobe pulse width	This is the strobe trigger output time (max. 65.535 ms). This time can be changed for each camera.

### ► Explanation of operation

- (1) When two cameras are connected, delay the shutter open/close timing of cameras 0 and 1 by the trigger delay time (T4) to prevent mutual interface.
- (2) The STGOUT signal is used to output the strobe firing trigger to the strobe device connected to the Controller. After the shutter opens, the STGOUT signal is output after the STGOUT delay time (T6) has elapsed, and the strobe fires. The ON/OFF polarity of the STGOUT signal can be changed.

## ENABLE Signal Output

The following three output pattern can be specified for ENABLE signal.

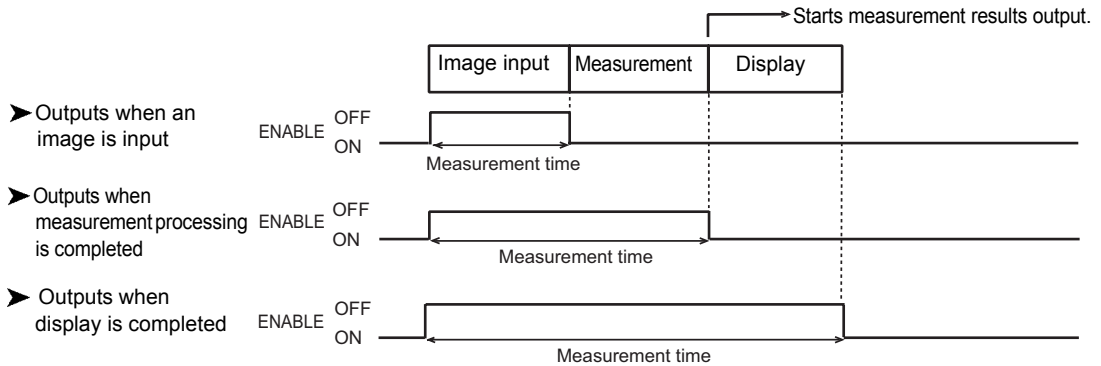

## OR Signal Output

The following two output pattern can be specified for the OR signal.

### ▶ Level output

Output of the overall judgment is retained until output of the next overall judgment.

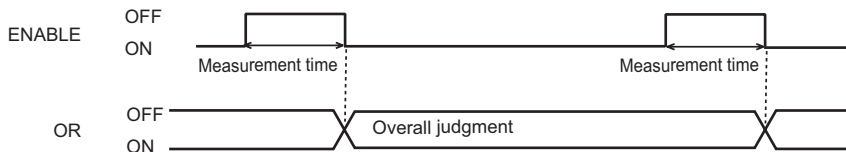

### ▶ One-shot output

The OR signal is remained to be ON during the output time set in [System/Comm/OR output/Output time] when [One-shot] is set in [System/Comm/OR output/Output mode].

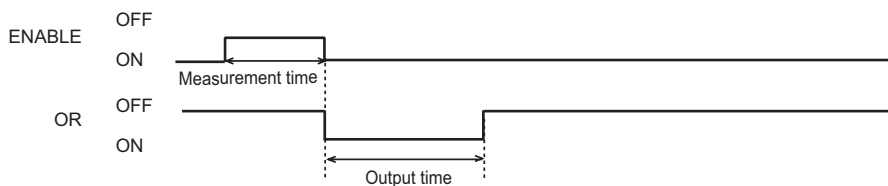

## Operation at Startup

This section shows the Controller's operation when it is powered ON in the RUN mode.

The following describes the order in which signals change.

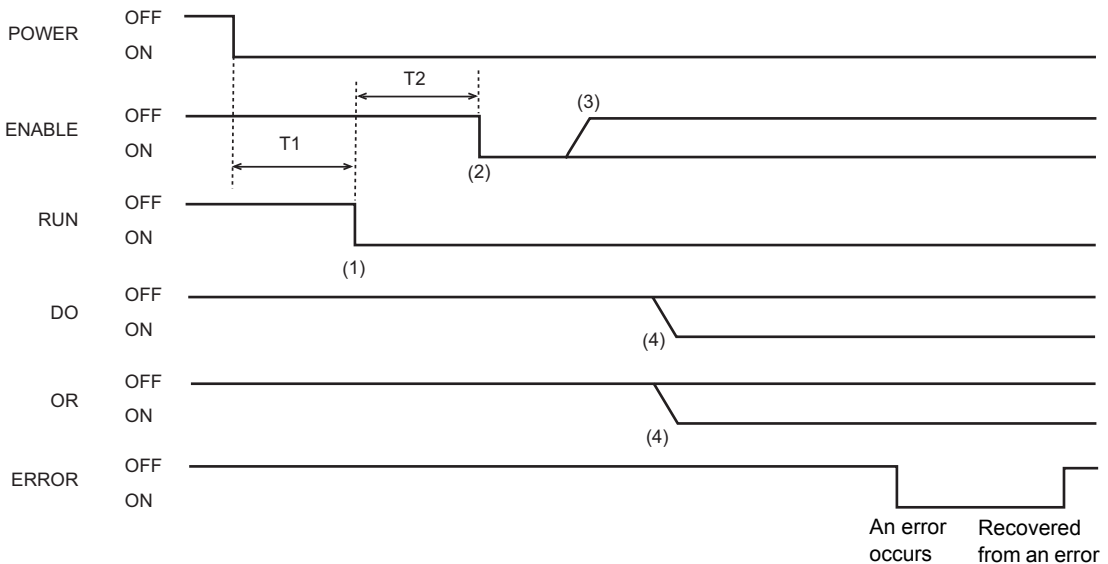

T1: Startup processing at power ON	The time required changes according to the settings.
T2: RUN mode initialization processing	The time required changes according to the settings.

### ► Explanation of operation

- (1) The RUN signal turns ON when the startup process is completed after the Controller is powered ON in the RUN mode.
- (2) When the RUN signal turns ON, initialization processing in the RUN mode is performed. When the initialization processing is completed, the ENABLE signal turns ON and command inputs can be accepted.
- (3) The ENABLE signal turns OFF when the Controller accepts command and stays OFF during processing commands.
- (4) The signal turns ON/OFF after output of data such as measurement results.

## Reset Input

Set the RESET signal to ON for at least 10 ms.

MEMO

# APPENDICES

---

<b>Error Messages and Corrective Actions</b>	<b>166</b>
<b>List of Available Functions for Each Camera</b>	<b>167</b>
<b>AUTO Setting</b>	<b>168</b>
AUTO Setting of Measurement Items	168
AUTO Setting in Individual Adjustment Screens	169
<b>Specifications and External Dimensions</b>	<b>170</b>
Camera	170
Controller	176
Accessories & Options	178
<b>LED Safety</b>	<b>187</b>
<b>Requirements from Regulations and Standards</b>	<b>188</b>
Summary of Requirements to Manufactures	188
Summary of Requirements to User	190
Definitions of Laser Classification	191
<b>Basic Knowledge for Operation</b>	<b>192</b>
<b>Menu List</b>	<b>196</b>
<b>INDEX</b>	<b>199</b>
<b>How Color Images are Processed</b>	<b>201</b>
Color Filter	202
Color Pickup	204
Hue, Saturation and Brightness Value	206
<b>Version Upgrade Information</b>	<b>207</b>
<b>Revision History</b>	<b>208</b>

# Error Messages and Corrective Actions

The following shows error messages that are displayed on the LCD screen and their corrective actions.

Error message	Probable cause	Reference
Draw at least one OR figure.	The NOT figure mode is used to delete part of a drawn area. Draw in the OR region.	p.194
SD card access error	An error occurred during accessing of the SD card. <ul style="list-style-type: none"> <li>• Make sure that the SD card is inserted.</li> <li>• Make sure that the SD card is not locked.</li> <li>• Make sure that the attribute of files on the SD card is not read-only.</li> <li>• Make sure that the SD card has not run out of free space.</li> </ul>	-
Illegal syntax in expression.	An operation expression setting is probably illegal as follows: <ul style="list-style-type: none"> <li>• The number of brackets on the left and right differ.</li> <li>• The region Nos. are continuous.</li> <li>• The operators are continuous.</li> <li>• The constants are continuous.</li> <li>• The functions are continuous.</li> <li>• There are not enough or too many function arguments.</li> </ul>	p.109
Automatic setting failed.	Make sure that images are being captured appropriately. If images are too dark, adjust the shutter speed or the brightness of the lighting.	p.98, 100
Camera error	A camera connection error occurred. Make sure that the connector between the camera and the Controller is connected correctly.	p.29
Calibration failed.	Execute sampling or specify points at three locations that are not on a straight line.	p.101
SYSTEM ERROR (BOOT error)	A hardware error occurred. A probable cause is a Controller malfunction. Contact an OMRON sales representative.	-
Communication error	A serial communications (RS-232C/422) error occurred. <ul style="list-style-type: none"> <li>• Make sure that the serial cable is connected correctly.</li> <li>• Make sure that the communications specifications of the Controller match those of the external device.</li> <li>• Make sure that the external device is operating correctly.</li> <li>• Make sure that the serial cable is not located near power lines or noise-generating sources.</li> </ul>	p.128
Input value is incorrect.	The input numerical values are not within the permissible range. Change the numerical values so that they are within the permissible range.	-
Password is incorrect.	Input the correct password.	p.136
Timeout error. (parallel I/O)	A timeout occurred in parallel I/O. <ul style="list-style-type: none"> <li>• Make sure that the DSA signal is connected correctly.</li> <li>• Make sure that the DSA signal is connected correctly to the host side.</li> </ul>	p.129
Insufficient free space of memory.	Delete unwanted banks and measurement items.	p.127
Model registration failed.	Make sure that images are being captured appropriately. If images are too dark, adjust the shutter speed or the brightness of the lighting.	p.98, 100
Loaded file is incorrect.	Specify the correct file and load the file again.	p.140
Fan error!	A fan error occurred. A probable cause is a Controller malfunction. Contact an OMRON sales representative.	-



# List of Available Functions for Each Camera

			Gain	Image Rate	Partial Function	Shutter Speed	Lighting control
Camera with lighting	Monochrome	ZFX-SR10	Available	Available	Not available	Available <sup>(*)1</sup>	Available
		ZFX-SR50	Available	Available	Not available	Available <sup>(*)1</sup>	Available
	Color	ZFX-SC10	Available	Not available	Available	Available <sup>(*)1</sup>	Available
		ZFX-SC50_	Available	Not available	Available	Available <sup>(*)1</sup>	Available
		ZFX-SC90_	Available	Not available	Available	Available <sup>(*)1</sup>	Available
		ZFX-SC150_	Available	Not available	Available	Available <sup>(*)1</sup>	Not available
Camera only	Monochrome	ZFX-S	Available	Available	Not available	Available <sup>(*)1</sup>	Not available
	Color	ZFX-SC	Available	Not available	Available	Available <sup>(*)1</sup>	Not available

\*1: The shutter speed is determined by the image rate and partial function settings.

## Image Rate/Partial Function and Shutter Speeds

		Shutter Speed (s)									
		1/170 1/200 1/300 1/500	1/1000	1/1400	1/1500	1/2000	1/2500	1/3000	1/4000	1/8000	1/20000
ZFX-SR_	Image rate Fine	(*2)	Available	Available	Available	Available	Available	Available	Available	Available	Available
	Image rate Normal	(*2)	(*2)	(*2)	(*2)	Available	Available	Available	Available	Available	Available
	Image rate High speed	(*2)	(*2)	(*2)	(*2)	(*2)	(*2)	(*2)	Available	Available	Available
ZFX-SC10 ZFX-SC50_ ZFX-SC90_	Partial function None	(*2)	Available	Available	Available	Available	Available	Available	Available	Available	Available
	Partial 1/2	(*2)	Available	Available	Available	Available	Available	Available	Available	Available	Available
	Partial 1/4	(*2)	(*2)	(*2)	(*2)	Available	Available	Available	Available	Available	Available
ZFX-SC150_ (*1)	Partial function None	(*2)	Available	Available	Available	Available	Available	Available	Available	Available	Available
	Partial 1/2	(*2)	Available	Available	Available	Available	Available	Available	Available	Available	Available
	Partial 1/4	(*2)	Available	Available	Available	Available	Available	Available	Available	Available	Available
ZFX-S	Image rate Fine	(*2)	Available	Available	Available	Available	Available	Available	Available	Available	Available
	Image rate Normal	(*2)	(*2)	(*2)	(*2)	Available	Available	Available	Available	Available	Available
	Image rate High speed	(*2)	(*2)	(*2)	(*2)	(*2)	(*2)	(*2)	Available	Available	Available
ZFX-SC	Partial function None	(*2)	Available	Available	Available	Available	Available	Available	Available	Available	Available
	Partial 1/2	(*2)	Available	Available	Available	Available	Available	Available	Available	Available	Available
	Partial 1/4	(*2)	(*2)	(*2)	(*2)	Available	Available	Available	Available	Available	Available

\*1: The LED lights for 1 ms only when it is turned ON/OFF.

\*2: These shutter speeds can be selected only when the lighting is turned OFF.

# AUTO Setting

Support functions for automatically optimally adjusting the measurement conditions are collectively referred to as the "AUTO setting."

The [AUTO] button is displayed at the bottom of screens that support execution of the AUTO setting.

The following explains the screens in which the [AUTO] button is displayed and items that are automatically set.

## AUTO Setting of Measurement Items

Basic setting of measurement items is completed by selecting the measurement item, setting measurement regions, and then executing automatic setting.

### step1

Selecting measurement items

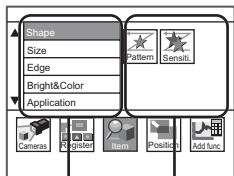

Measurement type group      Measurement items

### step2

Setting measurement regions

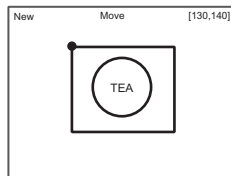

Enclose the desired measurement area.

### step3

Executing automatic setting

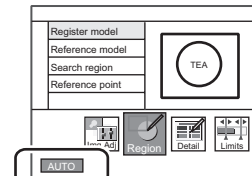

The optimum measurement conditions are automatically set just by selecting [AUTO]. Measurement conditions can also be checked and changed.

## Automatically Set Items

Item	Explanation
Color filter	The currently displayed image is analyzed to automatically select the optimum color filter for measurement items that use a color filter. (Measurement items that use a color filter: Pattern Search, Graphic Search, Flexible Search, Sensitive Search, Position, Width, Count, Grouping, Defect)
Model image	The image after the automatically set optimum color filter is applied is registered as the model for measurement items that use a model. When only the region is changed after AUTO setting is executed, the model image and not the color filter is updated. (Measurement items that require registration of the model: Pattern Search, Flexible Search, Sensitive Search)
Threshold	The threshold values are automatically set for the following measurement items: (Area, Labeling, Position, Width, Count, Bright, HUE)
Edge search color of detailed conditions	The edge search color of detailed conditions is automatically set for measurement items in edge inspection. (Measurement items in edge inspection: Position, Width and Count)
Reference value	The measurement value of the currently displayed image is registered as the reference value. This reference value is updated when the region is changed and AUTO setting need not be executed again.

# AUTO Setting in Individual Adjustment Screens

The ZFX displays candidates to support setting of items that take time to adjust.

## Automatic Pickup of Candidate Color

The currently displayed image is analyzed to pick up a maximum of four candidate colors for the measurement target.

 Color Pickup p.204

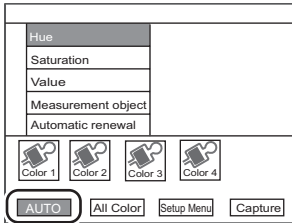

## AUTO Selection of Color Filter

The currently displayed image is analyzed to automatically select the optimum color filter.

This is used to adjust only the color filter independently of AUTO setting of measurement items.

 Color Filter p.202

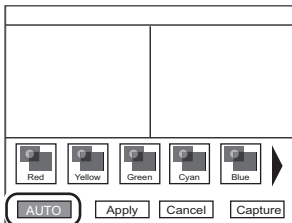

## AUTO Setting of Lighting

Candidate lighting patterns are displayed as images.

 Light Control (Recipe Functions) p.100

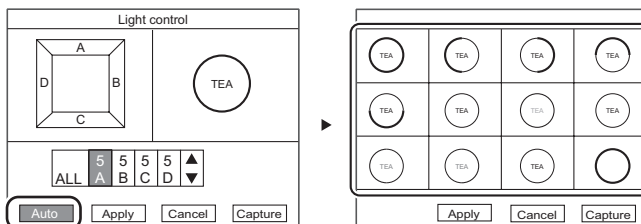

# Specifications and External Dimensions

## Camera

### Specifications

#### Camera with lighting

##### ZFX-SR10/SR50 (monochrome type)

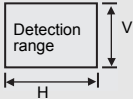
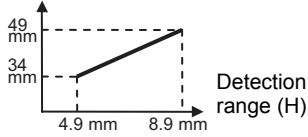
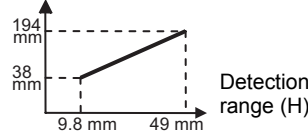
Item	ZFX-SR10	ZFX-SR50
Detection range (H x V) 	4.9 mm x 4.9 mm to 8.9 mm x 8.9 mm (variable range)	9.8 mm x 9.8 mm to 49 mm x 49 mm (variable range)
Setting distance (L)	34 mm to 49 mm	38 mm to 194 mm
Relationship between setting distance and detection range	Setting distance (L) 	Setting distance (L) 
Image capture element	All-pixel capture inter-line transfer type 1/3" CCD (monochrome)	
Effective number of pixels	659(H) x 494 (V)	
Pixel size	7.4 μm (H) x 7.4 μm (V)	
Shutter speed	1/170 to 1/20000 s	
Partial function (partial capture)	OFF	
Image rate function	Fine, Normal, High speed	
Frame rate (at capture of entire screen)	90 fps	
Lighting	Lighting method	Pulse lighting
	LED	Red LED
	Type	Direct lighting
	Guide light	Available (center, measurement region)
	Optional lighting I/F	Not available
Ratings	Power supply voltage (supplied from Controller)	15 VDC
	Current consumption	Approx. 200 mA
Operation environment robustness	Ambient temperature range	Operating: 0 to + 40°C, Storage: -20 to +65°C (with no icing or condensation)
	Ambient humidity range	Operating and storage: 35% to 85% (with no condensation)
	Ambient atmosphere	No corrosive gases allowed
	Degree of protection	IP65 (IEC60529)
	Dielectric strength	1000 VAC 50 Hz/60 Hz 1 min
	Vibration resistance (durability)	10 to 150 Hz Single-amplitude 0.35 mm 10 times for 8 min each in X, Y, and Z directions
	Shock resistance (destructive)	150 m/s <sup>2</sup> 3 times each in 6 directions (up/down, left/right, forward/backward)
Connection method	Cable built-in type (cable length: 2 m)	
Material	Case: ABS, mounting fixture: PBT	
Weight	Approx. 200 g (including mounting fixture and cable)	
Accessories	mounting fixture (ZFV-XMF) 1 p'ce, Ferrite core 2 p'ces, Instruction Sheet	

## ZFX-SC10/SC50/SC50W/SC90/SC90W/SC150/SC150W (color type)

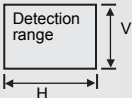
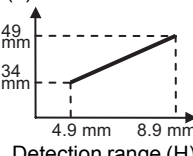
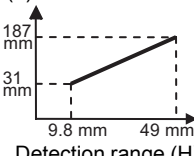
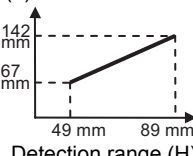
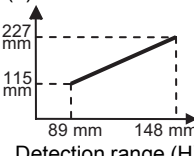
Item	ZFX-SC10	ZFX-SC50/SC50W	ZFX-SC90/SC90W	ZFX-SC150/SC150W	
Detection range (H x V) 	4.9 mm x 4.9 mm to 8.9 mm x 8.9 mm (variable range)	9.8 mm x 9.8 mm to 49 mm x 49 mm (variable range)	49 mm x 49 mm to 89 mm x 89 mm (variable range)	89 mm x 89 mm to 148 mm x 148 mm (variable range)	
Setting distance (L)	34 mm to 49 mm	31 mm to 187 mm	67 mm to 142 mm	115 mm to 227 mm	
Relationship between setting distance and detection range	Setting distance (L) 	Setting distance (L) 	Setting distance (L) 	Setting distance (L) 	
Image capture element	All-pixel capture inter-line transfer type 1/3" CCD (color)				
Effective number of pixels	659(H) x 494 (V)				
Pixel size	7.4 μm (H) x 7.4 μm (V)				
Shutter speed	1/170 to 1/20000 s				
Partial function (partial capture)	1/2 partial, 1/4 partial				
Image rate function	Not available				
Frame rate (at capture of entire screen)	90 fps				
Lighting	Lighting method	Pulse lighting			
	LED	White LED			
	Type	Direct lighting			
	Guide light	Not available			
	Optional lighting I/F	Not available	Available (ZFV-LT)		Not available
	Indicator Class <sup>*1</sup>	Class 1	Class 2	Class 2	Class 1
Ratings	Power supply voltage (supplied from Controller)	15 VDC	15 VDC, 48 VDC		
	Current consumption	Approx. 200 mA	Approx. 350 mA (15 VDC: approx. 150 mA, 48 VDC: approx. 200 mA) (including current consumption when optional lighting is connected)		
Operation environment robustness	Ambient temperature range	Operating: 0 to +40°C, Storage: -20 to +65°C (with no icing or condensation)			
	Ambient humidity range	Operating and storage: 35% to 85% (with no condensation)			
	Ambient atmosphere	No corrosive gases allowed			
	Degree of protection	ZFX-SC___: IP65 (IEC60529), ZFX-SC___W: IP67 (IEC60529)			
	Dielectric strength	1000 VAC 50 Hz/60 Hz 1 min			
	Vibration resistance (durability)	10 to 150 Hz Single-amplitude 0.35 mm Acceleration: 50 m/s <sup>2</sup> 10 times for 8 min each in X, Y, and Z directions			
	Shock resistance (destructive)	150 m/s <sup>2</sup> 3 times each in 6 directions (up/down, left/right, forward/backward)			
Connection method	Cable built-in type (standard cable length: 2 m)				
Material	Case: ABS, mounting fixture: PBT				
Weight	Approx. 200 g (including mounting fixture and cable)	Approx. 270 g (including mounting fixture and cable)	Approx. 300 g (including mounting fixture and cable)	Approx. 600 g (including mounting fixture and cable)	
Accessories	mounting fixture (ZFV-XMF) 1 p'ces, Ferrite core 2 p'ces, Instruction Sheet	mounting fixture (ZFV-XMF2) 1 p'ces, Ferrite core 2 p'ces, Warning label 1, Instruction Sheet	mounting fixture (ZFV-XMF2) 1 p'ces, Ferrite core 2 p'ces, Warning label 1, Instruction Sheet	Ferrite core 2 p'ces, Instruction Sheet	

\*1: Applicable standards IEC60825-1:1993 +A1:1997 +A2:2001, EN60825-1:1994 +A2:2001 +A1:2002

## Camera only

### ZFX-S/SC

Item	ZFX-S (monochrome type)	ZFX-SC (color type)
Image capture element	All-pixel capture inter-line transfer type 1/3" CCD (monochrome)	All-pixel capture inter-line transfer type 1/3" CCD (color)
Effective number of pixels	659 (H) x 494 (V)	
Pixel size	7.4 μm (H) x 7.4 μm (V)	
Shutter speed	1/170 to 1/20000 s	
Partial function (partial capture)	Not available	1/2 partial, 1/4 partial
Image rate function	Fine, Normal, High speed	Not available
Frame rate (at capture of entire screen)	90 fps	
Lens mount	C mount	
Lighting	Optional lighting I/F	Available External lighting: 3Z4S-LT *1 Flash Controller: made by Moritex Corporation 3Z4S-LT MLEK-C100E1TSX *1
Ratings	Power supply voltage (supplied from Controller)	15 VDC, 48 VDC
	Current consumption	Approx. 160 mA
Operation environment robustness	Ambient temperature range	Operating: 0 to + 50°C, Storage: -25 to +65°C (with no icing or condensation)
	Ambient humidity range	Operating and storage: 35% to 85% (with no condensation)
	Ambient atmo- sphere	No corrosive gases allowed
	Degree of protection	IP20 (IEC60529)
	Dielectric strength	500 VAC 50 Hz/60 Hz 1 min
	Vibration resis- tance (durability)	10 to 150 Hz Single-amplitude 0.35 mm Acceleration: 50 m/s <sup>2</sup> 10 times for 8 min each in X, Y, and Z directions
	Shock resistance (destructive)	150 m/s <sup>2</sup> 3 times each in 6 directions (up/down, left/right, forward/backward)
Connection method	Connector connection type (camera cable ZFX-VS/VSR required)	
Material	Case: Aluminum die cast alloy (C mount section), zinc die cast alloy (mounting base side), Cover: Zinc-plated copper plate 0.5 mm thick, Camera mounting base: ABS	
Weight	Approx. 80 g	
Accessories	Instruction Sheet	

\*1: 3Z4S-LT are not yet released for overseas.

## External Dimensions

### Camera with lighting

#### ZFX-SR10/SR50 (monochrome type)

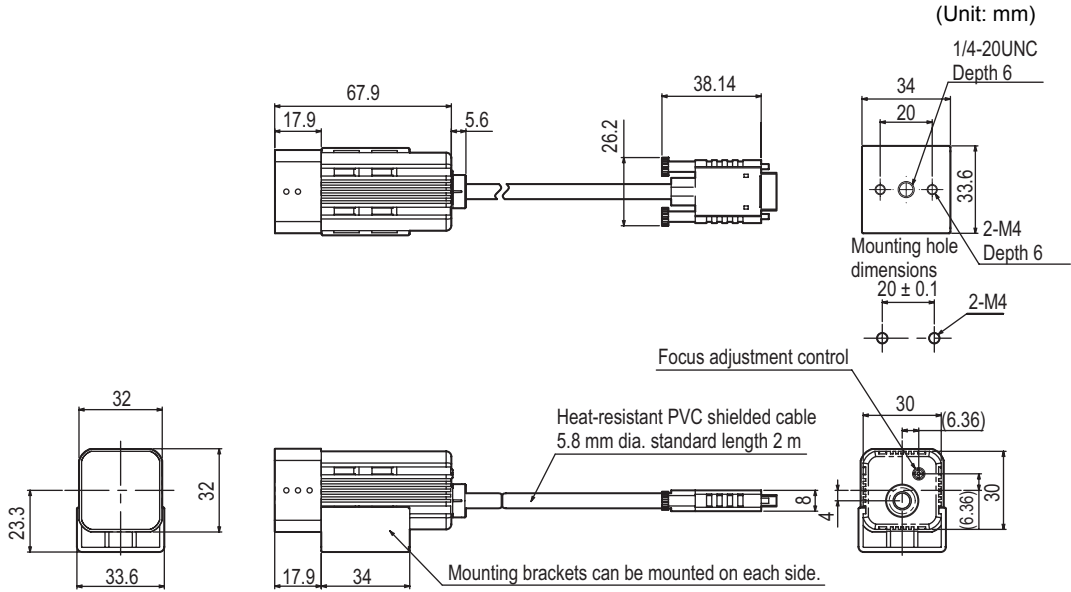

#### ZFX-SC10 (color type)

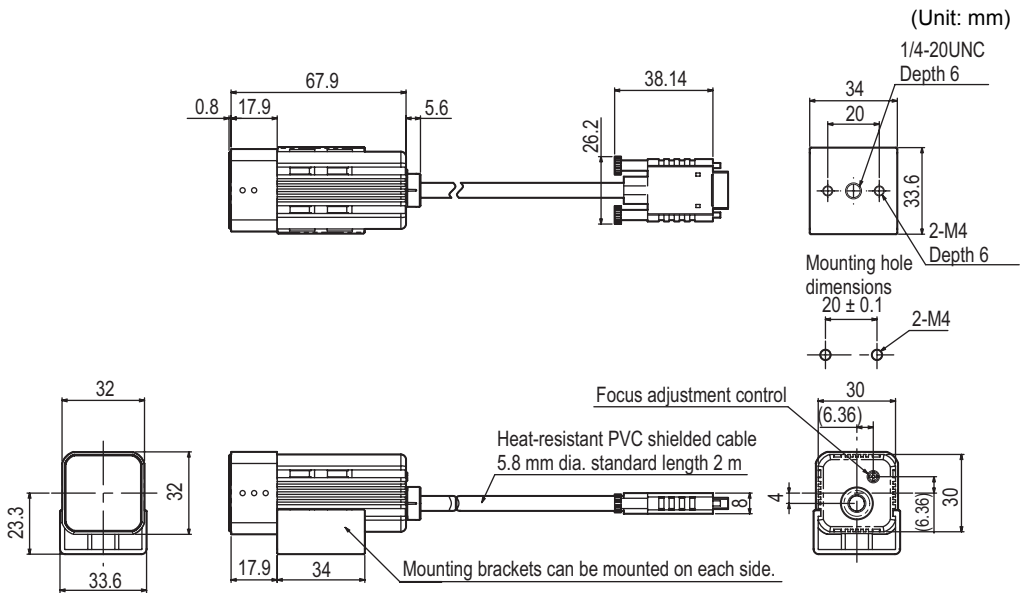

### ZFX-SC50/SC50W (color type)

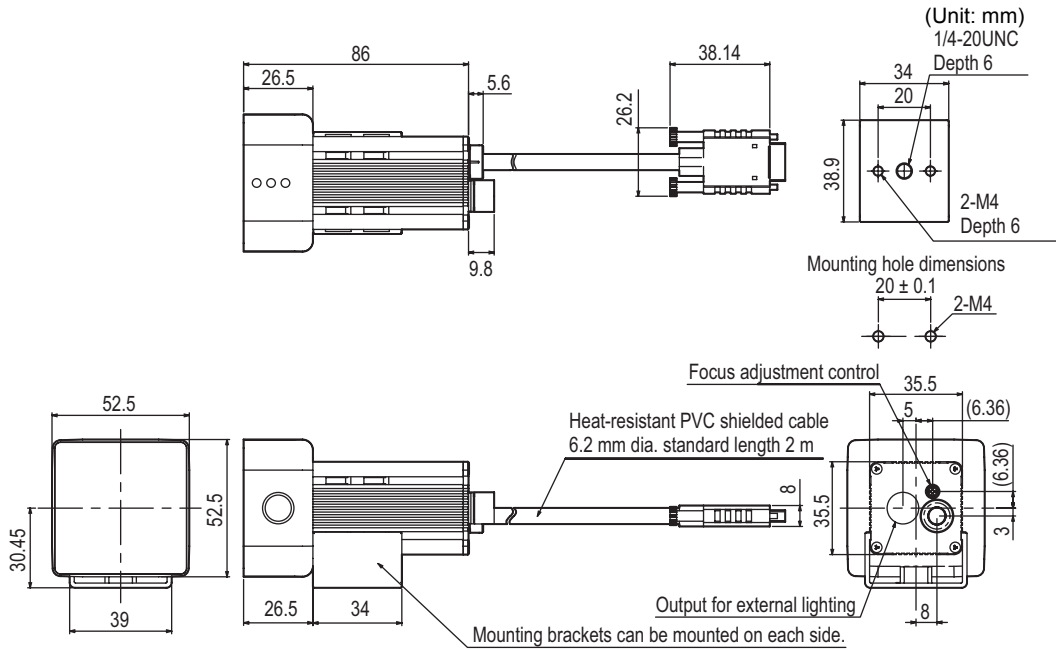

### ZFX-SC90/SC90W (color type)

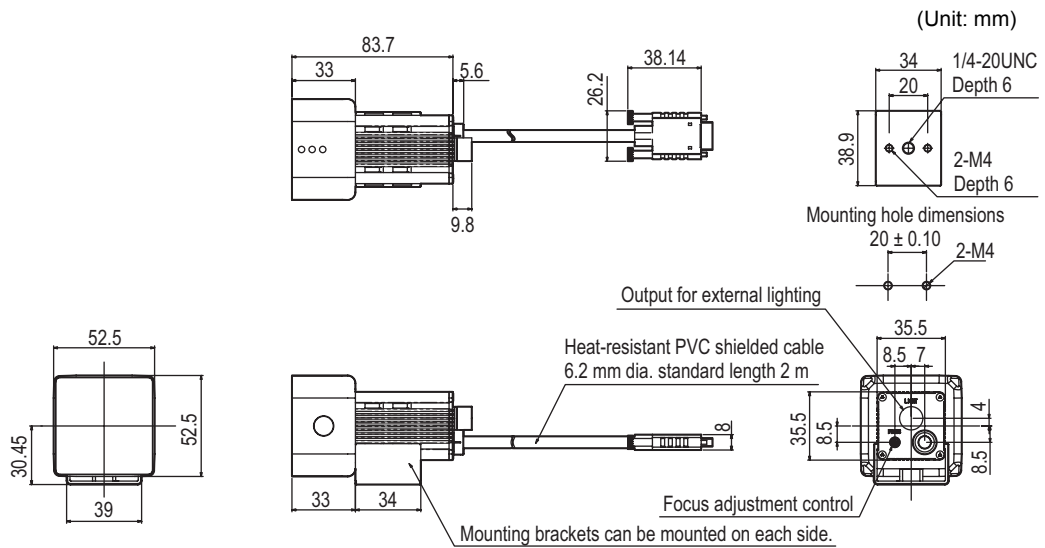



**ZFX-SC150/SC150W (color type)**

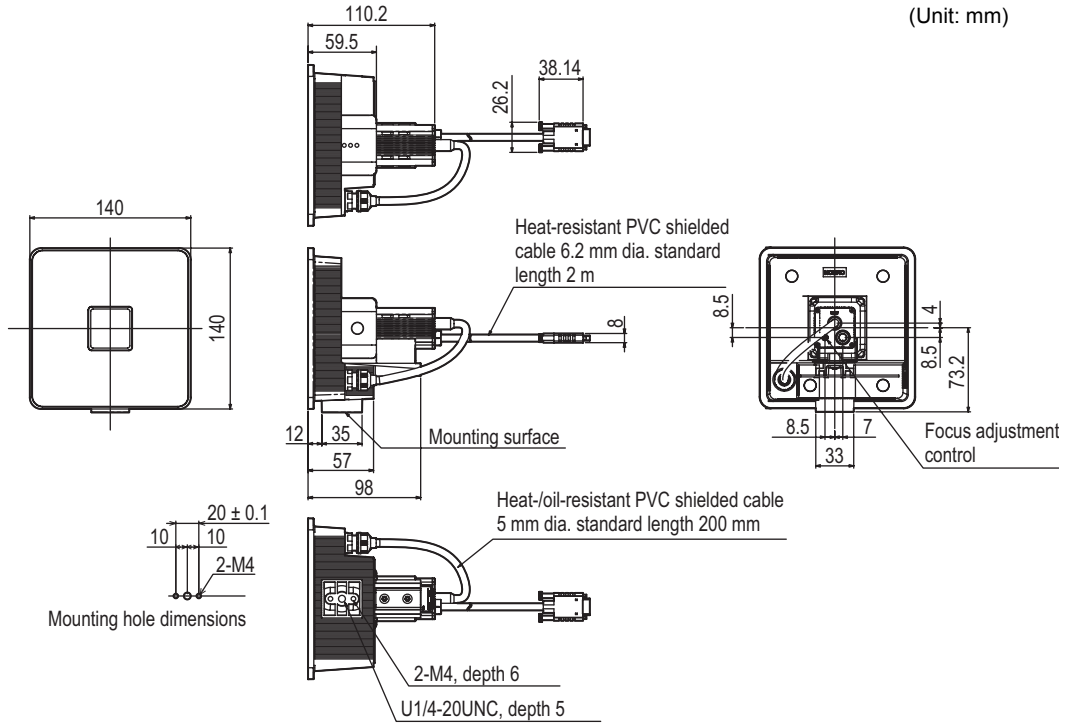

**Camera only**

**ZFX-S (monochrome type) /SC (color type)**

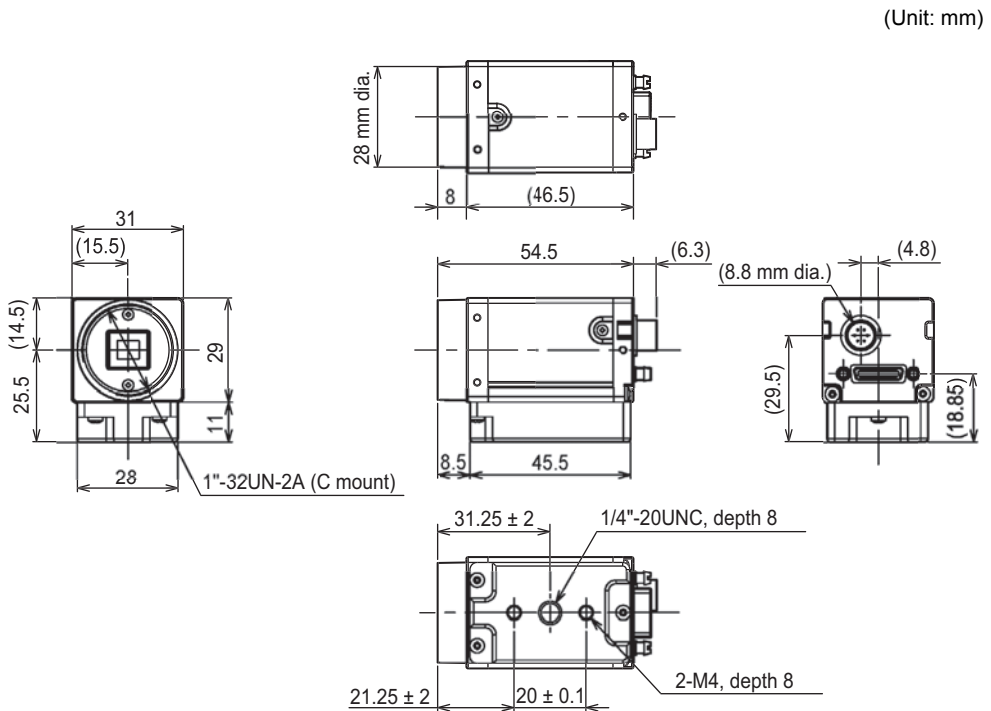

# Controller

## Specifications

### ZFX-C20/C25

Item		ZFX-C20	ZFX-C25	
Number of connected cameras		2		
Connectable camera		ZFX-SR_/SC_/S/SC		
Processing resolution		When ZFX-SR_/SC_ is connected:464 (H) x464 (V) When ZFX-S/SC is connected:608 (H) x464 (V)		
Display	LCD monitor	3.5" TFT color LCD (320 x 240 pixels)		
	Indicator	"Measuring" indicator (color: green): RUN Trigger indicator (color: blue): ENABLE Judgment indicator (color: orange): OUTPUT Error indicator (color: red): ERROR		
External I/F	Parallel interface	Input	12 points (RESET, DSA, DI0 to 8, TRIG)	
		Output	23 points (OR, ERROR, RUN, ENABLE, GATE, STGOUT0, DO0 to 15)	
		Circuit type	NPN	PNP
	Serial interface	USB2.0	1 port, FULL SPEED, MINI-B connector	
		RS-232C	1 port, max. 115200 bps (cannot be used simultaneously with RS-422 interface)	
		RS-422	1 port, max. 115200 bps (cannot be used simultaneously with RS-232C interface)	
	Network communications	Ethernet	1 port, 100BASE-TX/10BASE-T	
	Monitor output	Analog RGB output, 1 ch (resolution VGA: 640 x 480)		
Memory card I/F	SD card slot 1 ch			
Operation I/F		Touch panel, key operation, console connection		
Main functions	Number of registered banks		32 banks	
	Number of setup items		128 items/1 bank	
	Measurement items	Shape inspection	Pattern search, sensitive search, flexible search, graphic search	
		Size inspection	Area, labeling	
		Edge inspection	Position, width, count	
		Brightness/color inspection	Brightness, HUE	
		Application-based inspection	Defects, grouping	
Position correction		1 model search, 2 model search, position, area, labeling		
Additional functions	Image memory function		Max. 100 images (when 2 cameras are connected, 50 images/camera)	
	Analysis function		Logging monitor	
Menu language		Japanese/English (can be switched)		
Ratings	Power supply voltage	21.6 to 26.4 VDC (including ripple)		
	Current consumption	1.5 A max.		
	Insulation resistance	Across all lead wires and controller case: 20 MΩ (by 250 V megger)		
	Dielectric strength	Across all lead wires and controller case, 1000 VAC, 50/60 Hz, 1 min		
Operation environment robustness	Ambient temperature range	Operating: 0 to + 50°C, Storage: -15 to +60°C (with no icing or condensation)		
	Ambient humidity range	Operating and storage: 35% to 85% (with no condensation)		
	Ambient atmosphere	No corrosive gases allowed		
	Degree of protection	IP20 (IEC60529)		
	Vibration resistance (durability)	Vibration frequency: 10 to 150 Hz Single-amplitude: 0.35 mm Acceleration: 50 m/s <sup>2</sup> 10 times for 8 minutes in X, Y, and Z directions		
	Shock resistance (destructive)	150 m/s <sup>2</sup> 3 times each in 6 directions (up/down, left/right, forward/backward)		
Material		Case: Polycarbonate (PC), Plate face: PMMA		
Weight		Approx. 650 g		
Accessories		Touch pen (ZFX-TP), Exhaust unit (ZFX-EU), Terminal block adapter (ZFX-XTB), Terminal block adapter mounting screws (4 p'ces), Ferrite core (2 p'ces), Instruction Sheet, Power connector		

## External Dimensions

ZFX-C20/C25

(Unit: mm)

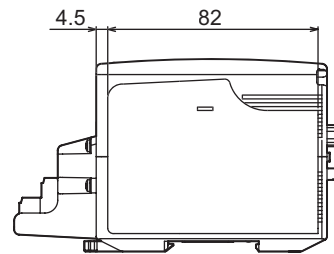
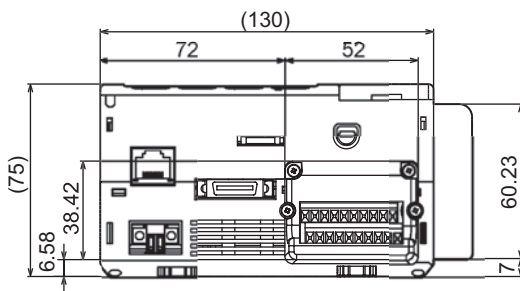
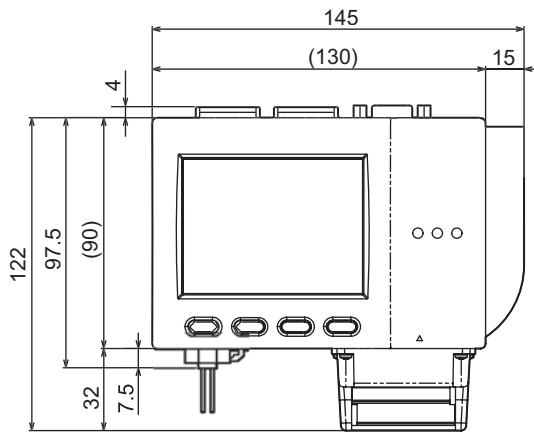

# Accessories & Options

## Camera Cable

### ZFX-VS 3M/8M, ZFX-VSR 3M

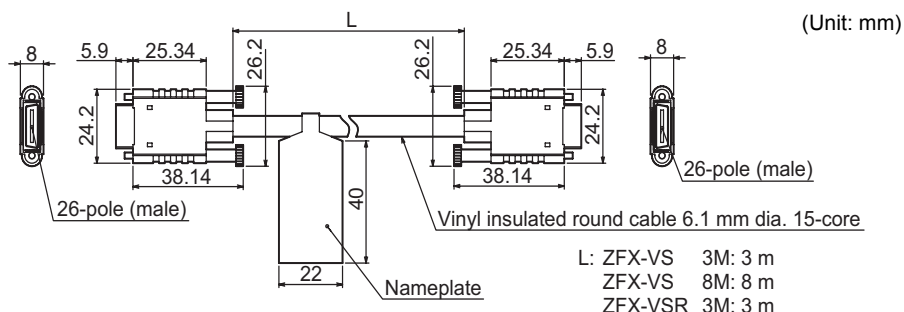

Item	ZFX-VS 3M	ZFX-VS 8M	ZFX-VSR 3M <sup>(*)</sup>
Applicable controller	ZFX		
Cable length	3 m	8 m	3 m
Minimum bending radius	40 mm		
Weight	Approx. 250 g	Approx. 550 g	Approx. 250 g

\*1: Robot cable type

## Camera Extension Cable

### ZFX-XC3A/XC8A, ZFX-XC3AR

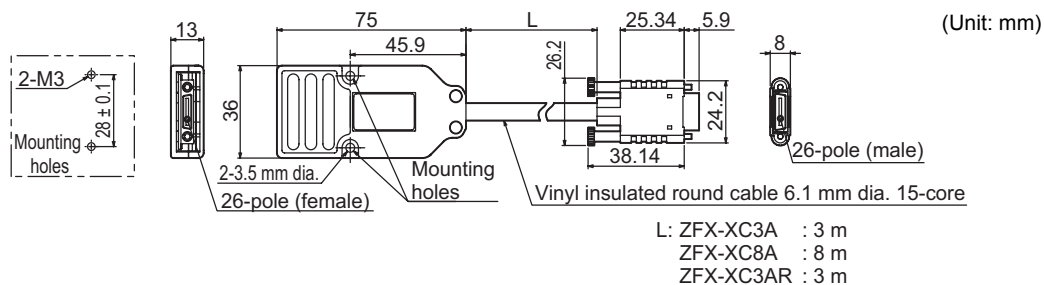

Item	ZFX-XC3A	ZFX-XC8A	ZFX-XC3AR <sup>(*)</sup>
Applicable controller/camera	ZFX		
Cable length	3 m	8 m	3 m
Minimum bending radius	40 mm		
Power supply voltage	15 VDC		
Current consumption	Approx. 30 mA (extension cable only. excluding camera)		
Ambient temperature range	Operating: 0 to +50°C, Storage: -20 to +65°C (with no icing or condensation)		
Ambient humidity range	Operating and storage: 35% to 85% (with no condensation)		
Vibration resistance (durability)	10 to 150 Hz Single-amplitude 0.35 mm 10 times for 8 min each in X, Y, and Z directions		
Shock resistance (destructive)	150 m/s <sup>2</sup> 3 times each in 6 directions (up/down, left/right, forward/backward)		
Material	Case: Polycarbonate (PC)		
Weight	Approx. 250 g	Approx. 550 g	Approx. 250 g

\*1: Robot cable type

## Parallel I/O Cable

### ZFX-VP

Item	ZFX-VP
Cable length	2 m, 5 m
Minimum bending radius	5.5 mm
Material	Cable sheath: Non-lead heat-resistant vinyl, Connector: PBT resin/polyamide resin
Weight	2 m type approx. 100 g, 5 m type approx. 250 g

# RS-232C/422 Cable

## ZFX-XPT2A (RS-232C), ZFX-XPT2B (RS-422)

(Unit: mm)

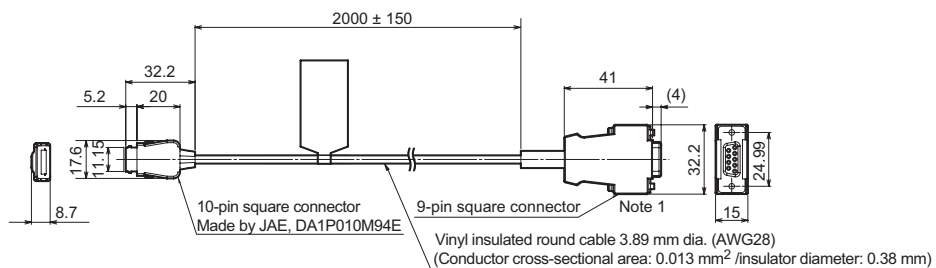

Note 1: Plug type connector

### ZFX-XPT2A

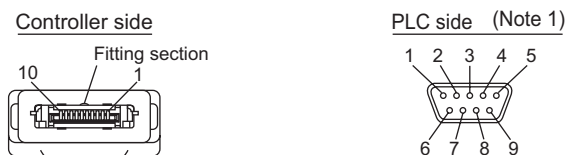

Signal name	Pin No.	Pin No.	Signal name
FG	1	1	FG
SD	2	2	SD
RD	3	3	RD
NC	4	4	RS
NC	5	5	CS
NC	6	6	NC
NC	7	7	NC
NC	8	8	NC
GND	9	9	GND
FG	10		
FG	Shell	Shell	FG

Note 1: Male connector

### ZFX-XPT2B

Signal name	Pin No.	Pin No.	Signal name
FG	1	1	SDA(-)
NC	2	2	SDB(+)
NC	3	3	NC
NC	4	4	NC
RDB(+)	5	5	NC
RDA(-)	6	6	RDA(-)
SDB(+)	7	7	NC
SDA(-)	8	8	RDB(+)
GND	9	9	GND
FG	10		
FG	Shell	Shell	FG

Note 1: Male connector

Item	ZFX-XPT2A	ZFX-XPT2B
Cable length	2 m	
Minimum bending radius	22.8 mm	
Material	Cable sheath: Heat-resistant vinyl chloride (PVC)	
Weight	Approx. 50 g	

# LCD Monitor

## FZ-M08

(Unit: mm)

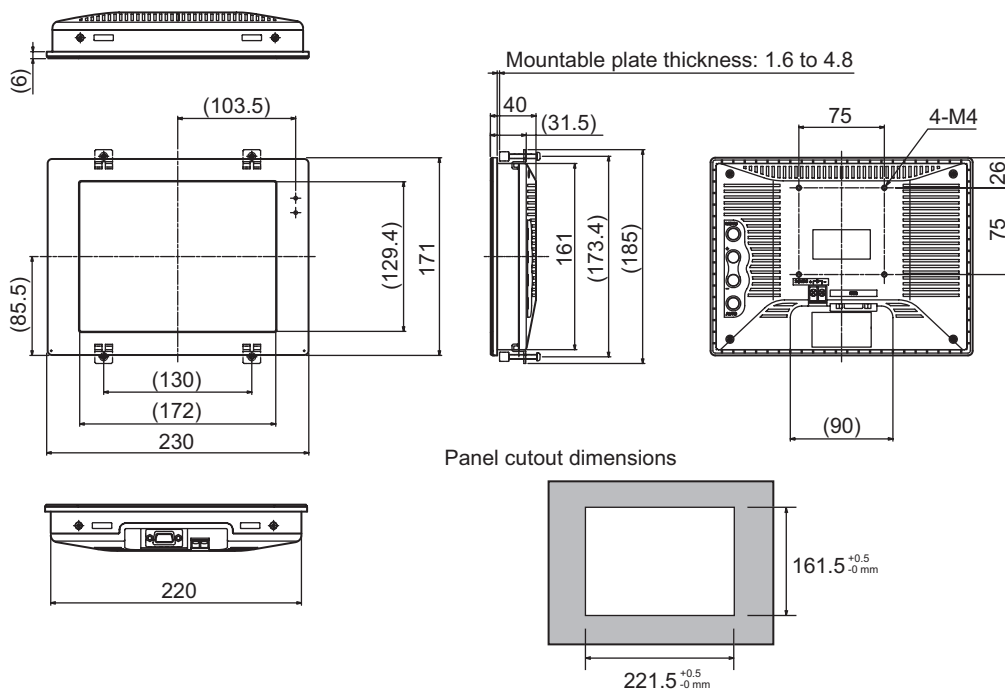

Item	FZ-M08
Power supply voltage	21.6 to 26.4 VDC
Current consumption	0.7 A max.
Video input signal	Analog RGB video input 1 ch
Screen size	21.3 cm across corners, 8.4 type or equivalent
Number of pixels	1024 (vertical) x 768 (horizontal) pixels
Number of display colors	16.7 million (8 bits/color)
Brightness <sup>(*)</sup>	300 cd/m <sup>2</sup>
Contrast ratio <sup>(*)</sup>	400:1
Visible angle <sup>(*)</sup>	Left/right: Angle 65°, Up: 60°, Down: 50° (contrast ratio 10:1 min.)
Backlight	Edge light system, CCFL2 light
Dielectric strength	Across all DC external terminals and GND: 840 VAC 50/60 Hz
Vibration resistance	10 to 150 Hz Single-amplitude 0.1 mm (max. acceleration 15 m/s <sup>2</sup> ) 10 times for 8 min each in 3 directions
Ambient temperature range	Operating: 0 to +50°C, Storage: -20 to +60°C
Ambient humidity range	Operating and storage: 20% to 85% (with no condensation)
Degree of protection	IP20 (IEC60529)
Material	Case: PC/PBT, Buttons: ABS
Weight	Approx. 1,200 g

\*1: Specifications of LCD panel. The optical characteristics differ slightly as a protective cover is attached on this product.

## Monitor Cable

### FZ-VM

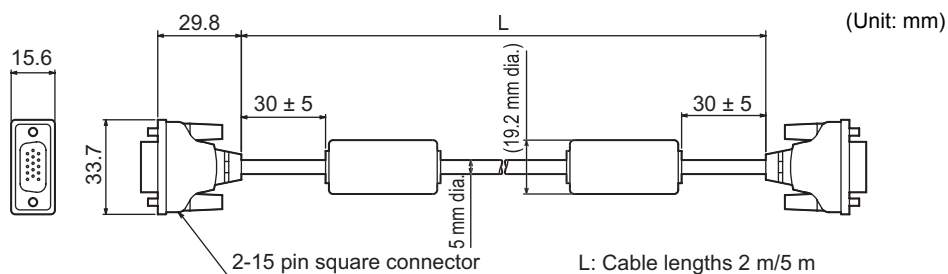

Item	FZ-VM
Material	Cable sheath: Heat-resistant PVC, Connector: PVC
Minimum bending radius	75 mm
Weight	Approx. 170 g

## Console

### ZFX-KP

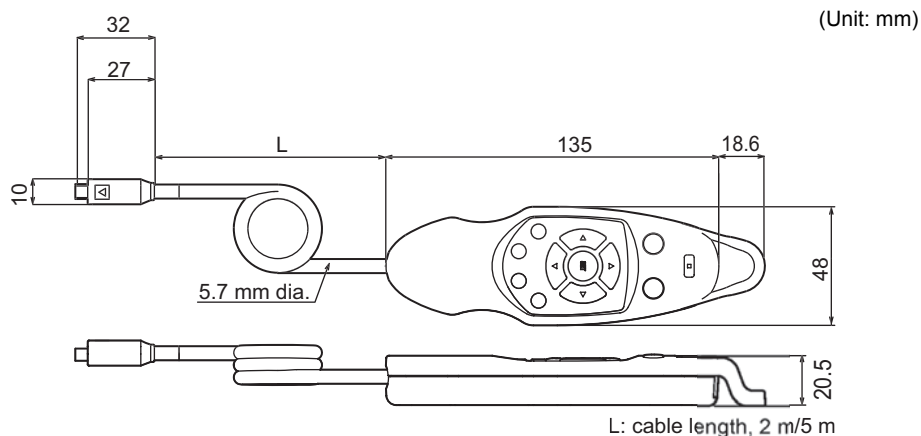

Item	ZFX-KP
Current consumption	Max. 14 mA (when all buttons are pressed)
Cable length	2 m, 5 m
Minimum bending radius	75 mm
Ambient temperature range	Operating: 0 to +50°C, Storage: -15 to +60°C (with no icing or condensation)
Ambient humidity range	Operating and storage: 35% to 85% (with no condensation)
Vibration resistance (durability)	10 to 150 Hz (0.7 mm double amplitude), 80 min each in X, Y and Z directions
Shock resistance (destructive)	300 m/s <sup>2</sup> 3 times each in 6 directions (up/down, left/right, forward/backward)
Material	Body: ABS, Cable sheath: PVC, Connector: 66 nylon
Weight	Approx. 260 g (5 m)/Approx. 150 g (2 m)

#### Note

Key entry switches are located on the rear of the console.

ENABLE: Entry by console keys is enabled.

DISABLE: Entry by console keys is disabled.(excluding the MENU/ADJ/RUN mode switch)



# Panel Mount Adapters

## ZFX-XPM

(Unit: mm)

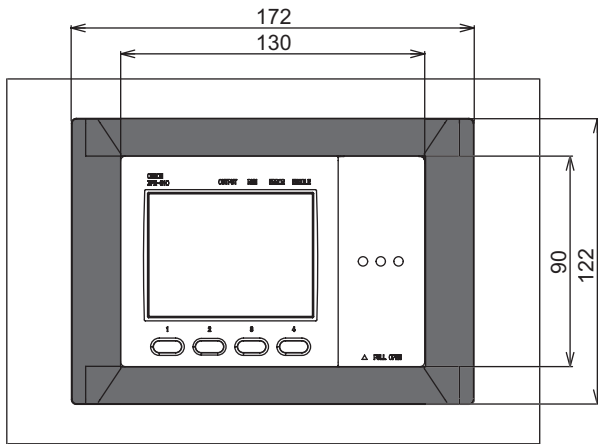

Panel cutout dimensions

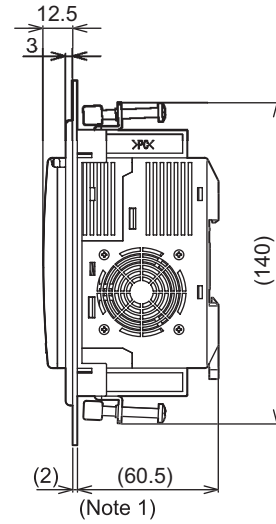
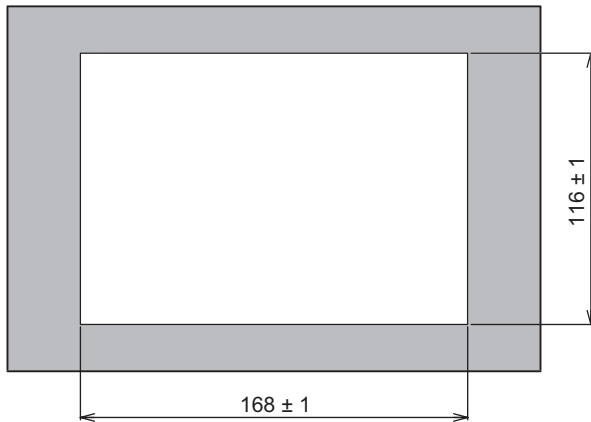

Note 1:  
Dimensions when the panel thickness is 2.0 mm

Item	ZFX-XPM
Applicable controller	ZFX
Material	Polycarbonate (PC)
Weight	Approx. 100 g

## Optional Lighting

### ZFV-LTL01 (bar lighting)

(Unit: mm)

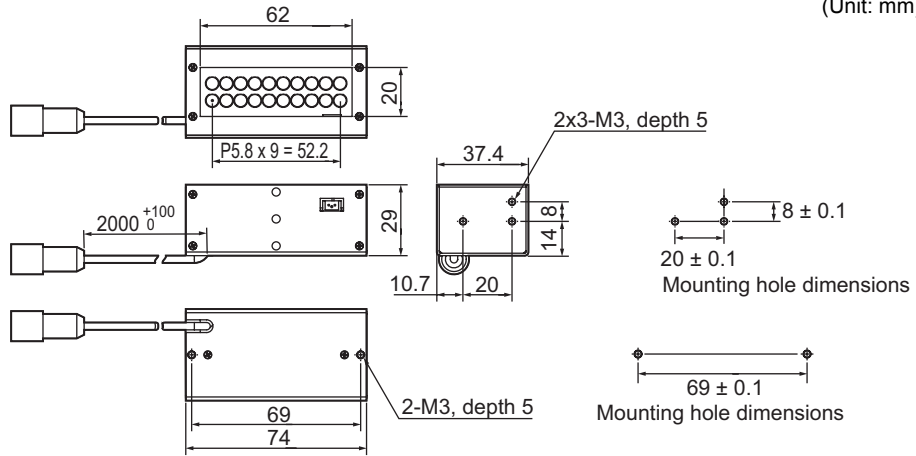

### ZFV-LTL02 (bar double-lighting)

(Unit: mm)

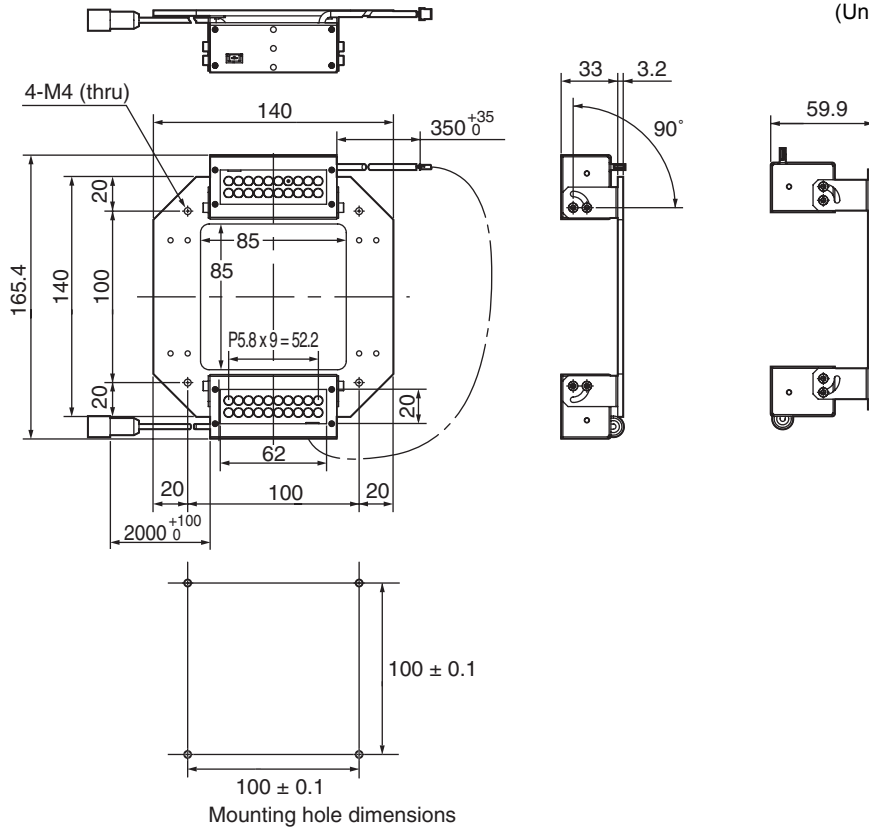

**ZFV-LTL04 (bar low-angle lighting)**

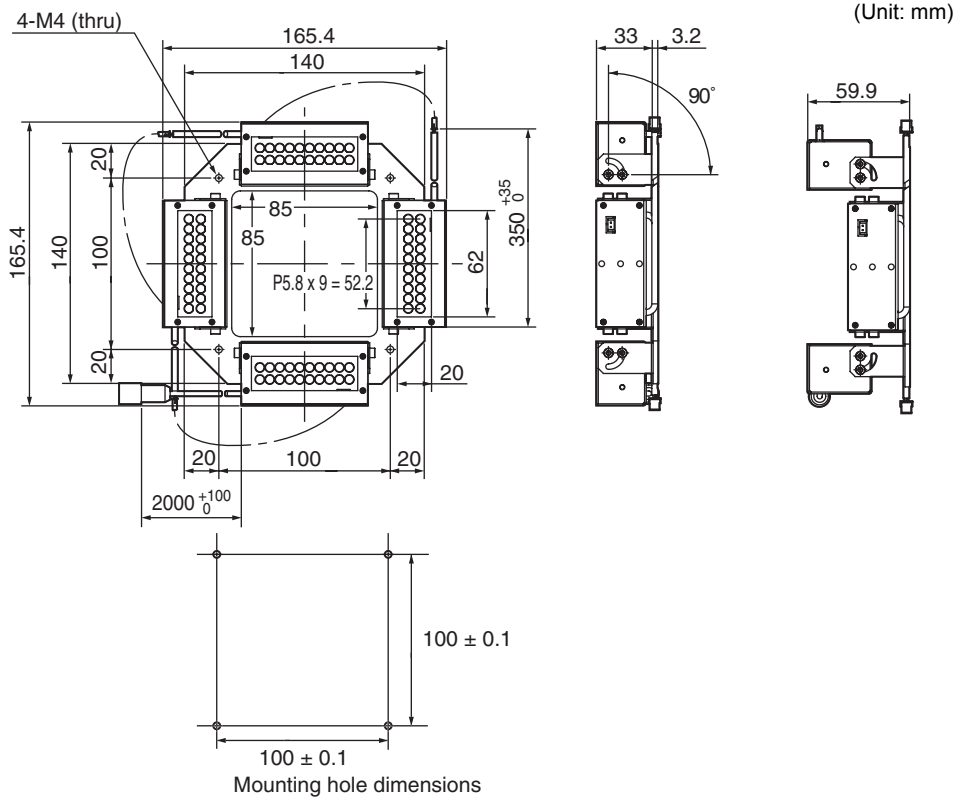

**ZFX-LTF01 (light source for through-beam lighting)**

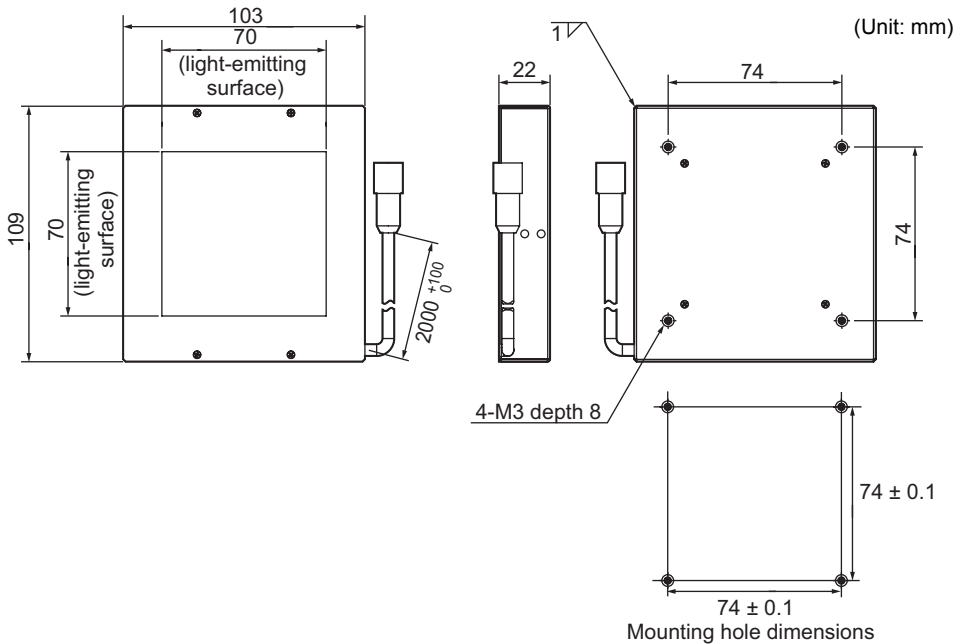

Item	ZFV-LTF01	ZFV-LTL01	ZFV-LTL02	ZFV-LTL04
Applicable camera	ZFV, ZFX			
Lighting method	Pulse lighting			
Lighting interval	Fixed (1.1 to 1.4 ms)			
Lighting source	White LEDs x 60 p'ces	White LEDs x 20 p'ces	White LEDs x 40 p'ces	White LEDs x 80 p'ces
Power supply voltage	48 VDC (supplied from camera)			
Current consumption	Approx. 160 mA	Approx. 80 mA	Approx. 120 mA	Approx. 210 mA
Dielectric strength	300 VAC 50 Hz/60 Hz 1 min			
Vibration resistance (durability)	10 to 150 Hz Single-amplitude 0.35 mm 10 times for 8 min each in X, Y, and Z directions			
Shock resistance (destructive)	150 m/s <sup>2</sup> 3 times each in 6 directions (up/down, left/right, forward/backward)			
Ambient temperature range	Operating: 0 to +40°C, Storage: -20 to +65°C (with no icing or condensation)			
Ambient humidity range	Operating and storage: 35% to 85% (with no condensation)			
Ambient atmosphere	No corrosive gases allowed			
Connection method	Cable built-in type (standard cable length: 2 m)			
Degree of protection	IP20 (IEC60529)			
Material	SPCC	SPCC, aluminum		
Weight	Approx. 500 g (packaged state: approx. 550 g)	Approx. 250 g (packaged state: approx. 300 g)	Approx. 650 g (packaged state: approx. 900 g)	Approx. 900 g (packaged state: approx. 1,150 g)
LED Class <sup>*1</sup>	Class 1			

\*1: Applicable standards IEC60825-1:1993 +A1:1997 +A2:2001, EN60825-1:1994 +A2:2001 +A1:2002

# LED Safety

For LED devices, class classification to indicate dangerous level and safety standards are stipulated in respective countries.

Take necessary safety preventive measures according to the standards.

## Classification

Standards and classifications (*1)	
JIS C 6802 (Japan) EN60825/IEC60825-1 (Europe)	FDA (the U.S.A.)
ZFX-SC50/SC50W/SC90/SC90W: Class 2 ZFX-SC10/SC150/SC150W: Class 1	(Exception)

\*1: Safety standards vary with the country in which the instrument is to be used (except for Japan, Europe and the U.S.A.). Refer to the safety regulations and standards for laser devices stipulated in the country in which the instrument is to be used.

## Warning Label

Warning labels are supplied as accessories with the ZFX-SC50/SC50W/SC90/SC90W.

Affix them to appropriate positions near the sensor where they can be easily noticed.

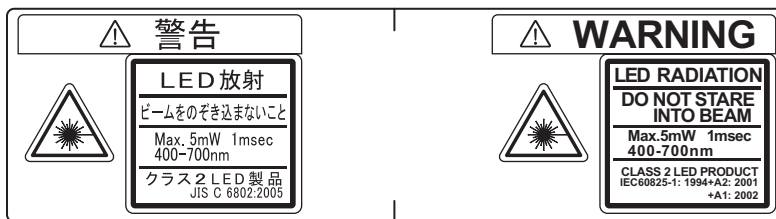

# Requirements from Regulations and Standards

## Summary of Requirements to Manufactures

### For Europe

EN 60825-1 "Safety of Laser Products, Equipment Classification, Requirements and User's Guide"  
Summary of Manufacturer's Requirements

Requirements subclause	Classification						
	Class 1	Class 1M	Class 2	Class 2M	Class 3R	Class 3B	Class 4
Description of hazard class	Safe under reasonably foreseeable conditions	As for Class 1 except may be hazardous if user employs optics	Low power; eye protection normally afforded by aversion responses	As for Class 2 except may be more hazardous if user employs optics	Direct intra-beam viewing may be hazardous	Direct intra-beam viewing normally hazardous	High power; diffuse reflections may be hazardous
Protective housing	Required for each laser product; limits access necessary for performance of functions of the products						
Safety interlock in protective housing	Designed to prevent removal of the panel until accessible emission values are below that for Class 3R				Designed to prevent removal of the panel until accessible emission values are below that for Class 3B		
Remote control	Not required					Permits easy addition of external interlock in laser installation	
Key control	Not required					Laser inoperative when key is removed	
Emission warning device	Not required				Give audible or visible warning when laser is switched on or if capacitor bank of pulsed laser is being charged. For Class 3R only, applies invisible radiation is emitted		
Attenuator	Not required					Give means beside the On/Off switch to temporarily to block beam	
Location controls	Not required				Controls so located that there is no danger of exposure to AEL above Classes 1 or 2 when adjustments are made		
Viewing optics	Not required	Emission from all viewing systems must be below Class 1M AEL					
Scanning	Scan failure shall not cause product to exceed its classification						
Class label	Required wording		Figures A required wording				
Aperture label	Not required				Specified wording required		
Service entry label	Required as appropriate to the class of accessible radiation						
Override interlock label	Required under certain conditions as appropriate to the class of laser used						
Wavelength range label	Required for certain wavelength ranges						

Requirements subclause	Classification						
	Class 1	Class 1M	Class 2	Class 2M	Class 3R	Class 3B	Class 4
LED label	Make required word substitutions for LED products						
User information	Operation manuals must contain instructions for safe use. Additional requirement apply for Class 1M and Class 2M						
Purchasing and service information	Promotion brochures must specify product classification; service manuals must contain safety information						

- Note:**
1. This table is intended to provide a convenient summary of requirements. See text of this standard for complete requirements.
  2. For the safety medical laser products, IEC 60601-2-22 applies
  3. AEL: Accessible Emission Limit  
The maximum accessible emission level permitted within a particular class. For your reference, see ANSI Z136.1-1993, Section 2.

Symbol and border: black  
Background: yellow

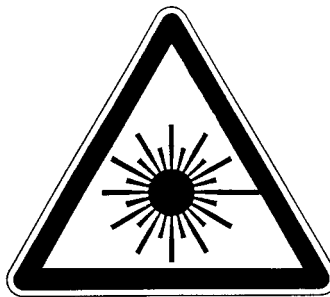

**Figure A Warning label - Hazard symbol**

Legend and border: black  
Background: yellow

# Summary of Requirements to User

## For Europe

EN 60825-1

Requirements subclause	Classification						
	Class 1	Class 1M	Class 2	Class 2M	Class 3R	Class 3B	Class 4
Laser safety officer	Not required but recommended for applications that involve direct viewing of the laser beam				Not required for visible emission Required for non-visible emission	Required	
Remote interlock	Not required					Connect to room or door circuits	
Key control	Not required					Remove key when not in use	
Beam attenuator	Not required					When in use prevents inadvertent exposure	
Emission indicator device	Not required				Indicates laser is energized for non-visible wavelengths	Indicates laser is energized	
Warning signs	Not required					Follow precautions on warning signs	
Beam path	Not required	Class 1M as for Class 3B (see note 2)	Not required	Class 2M as for Class 3B (see note 3)	Terminate beam at end of useful length		
Specular reflection	No requirements	Class 1M as for Class 3B (see note 2)	No requirements	Class 2M as for Class 3B (see note 3)	Prevent unintentional reflections		
Eye protection	No requirements				Not required for visible emission Required for non-visible emission	Required if engineering and administrative procedures not practicable and MPE exceeded	
Protective clothing	No requirements					Sometimes required	Specific requirements
Training	No requirements	Class 1M as for Class 3R (see note 2)	No requirements	Class 2M as for Class 3R (see note 3)	Required for all operator and maintenance personnel		

**Note:** 1. This table is intended to provide a convenient summary of requirements. See text of this standard for complete precautions.

2. Class 1M laser products that failed condition 1 of table 10 of the standard. Not required for Class 1M laser products that failed condition 2 of table 10 of the standard. See the text for details.

3. Class 2M laser products that failed condition 1 of table 10 of the standard. Not required for Class 2M laser products that failed condition 2 of table 10 of the standard. See the text for details.



# Definitions of Laser Classification

## For Europe

### Laser Product Classifications

EN

Class	Description
Class 1	Laser that are safe under reasonably foreseeable conditions of operation, including the use of optical instruments for intrabeam viewing.
Class 1M	Laser emitting in the wavelength range from 302.5 nm to 4000 nm which are safe under reasonably foreseeable conditions of operation, but may be hazardous if the user employs optics within the beam.
Class 2	Laser that emit visible radiation in the wavelength range from 400 nm to 700 nm where eye protection is normally afforded by aversion responses, including the blink reflex. This reaction may be expected to provide adequate protection under reasonably foreseeable conditions of operation including the use of optical instruments for intrabeam viewing.
Class 2M	Laser that emit visible radiation in the wavelength range from 400 nm to 700 nm where eye protection is normally afforded by aversion responses, including the blink reflex. However, viewing of the output may be more hazardous if the user employs optics within the beam.
Class 3R	Laser that emit in the wavelength range from 302.5 nm to 10 <sup>6</sup> nm where direct intrabeam viewing is potentially hazardous but the risk is lower than for Class 3B lasers, and fewer manufacturing requirements and control measures for the user apply than for Class 3B lasers. The accessible emission limit is within five times the AEL of Class 2 in the wavelength range from 400 nm to 700 nm and within five times the AEL of Class 1 for other wavelengths.
Class 3B	Lasers that are normally hazardous when direct intrabeam exposure occurs (i.e. within the NOHD). Viewing diffuse reflections is normally safe (see also note).
Class 4	Lasers which are also capable of producing hazardous diffuse reflections. They may cause skin injuries and could also constitute a fire hazard. Their use requires extreme caution.

**Note:** Conditions for safe viewing of diffuse reflections for Class 3B visible lasers are: minimum viewing distance of 13 cm between screen and cornea and a maximum viewing time of 10 s. Other viewing conditions require a comparison of the diffuse reflection exposure with the MPE.

# Basic Knowledge for Operation

## Input Methods

The ZFX-C uses three input methods: input by the touch pen, input by operating the keys on the front of the Controller, and input from the console.

### Input by the touch pen

#### <Tapping>

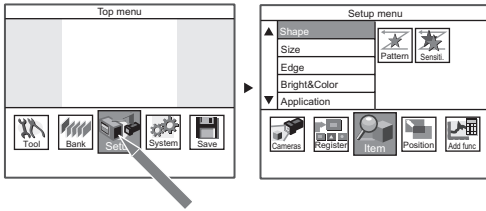

Tap the desired part with the touch pen.

This selects/applies the part you tapped.

#### <Dragging>

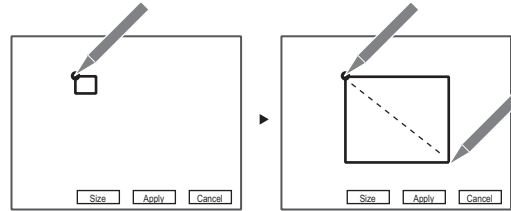

Tap any point in the screen and move the touch pen in this state.

The region is moved or resized by the amount that the touch pen is moved.

### Key entry from the Controller/Console

#### Controller

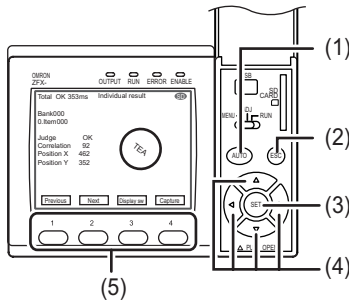

#### Console

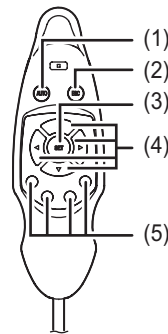

Name	Function
(1) AUTO key	Executes automatic setup of measurement conditions. This key is enabled only when the [AUTO] icon is displayed on the LCD screen.
(2) ESC key	Returns to the previous menu or cancels the current menu.
(3) SET key	Applies each item.
(4) ← L key → R key ↑ UP key ↓ DOWN key	Changes movement of the focus or numerical values in the following screens: <ul style="list-style-type: none"> <li>Item selection</li> <li>Threshold value parameter selection</li> <li>Parameter setup</li> <li>Measurement region setup</li> <li>Numerical value setup</li> </ul>
(5) Function keys	Directly sets each item that is displayed on the LCD screen. The function varies according to the display screen.

Order of focus movement

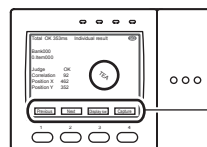
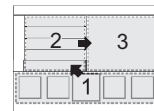

Menu button  
Displays the function corresponding to the function key.

## Parameter Setup

### Setting numerical values

A software keyboard is displayed on screen for parameters that require input of numerical values. Operate this software keyboard to input numerical values.

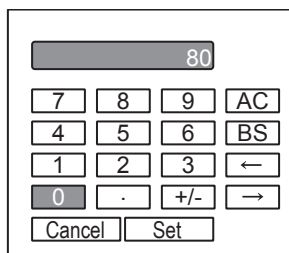

### Setting numerical values by the bar display

#### Touch pen input

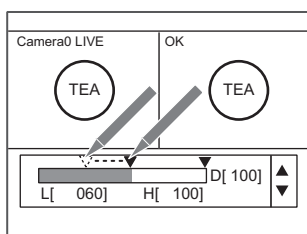

Tap and drag the ▾.

<To input numerical values directly>

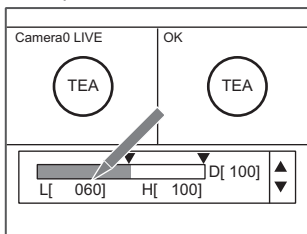

Tap the numerical value display.

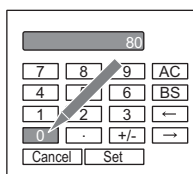

Set and apply the numerical values on the software keyboard.

#### Key input

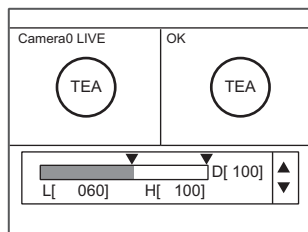

Select the target for input of the numerical values using the ← L key/→ R key, and press the SET key.

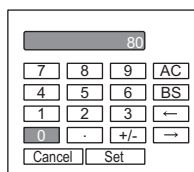

Set and apply the numerical values on the software keyboard.

## Setting the Region

### Moving and resizing regions

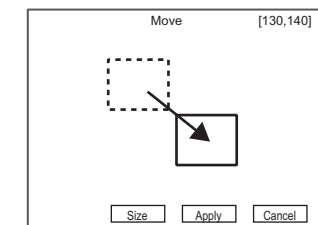

Size button ↓ ↑ Move button

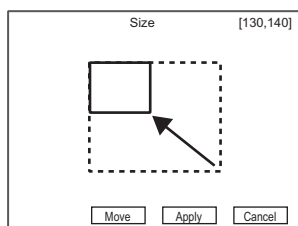

#### <Moving regions>

##### Touch pen operation

Tap any point in the screen and drag the touch pen in this state. The region moves by the amount that the touch pen is dragged (X, Y).

##### Key operation

↑ UP key: Moves the region upwards.  
↓ DOWN key: Moves the region downward.  
→ R key: Moves the region to the right.  
← L key: Moves the region to the left.  
(Holding the keys down moves the region at high speed.)

#### <Resizing regions>

##### Touch pen operation

Tap any point in the screen and drag the touch pen in this state. The region is resized (enlarged or reduced) by the amount that the touch pen is dragged (X, Y).

Also, you can drag somewhere else on screen to set a region on top of [Cancel] or other buttons at the bottom of the screen, and resize the region.

##### Key operation

↓ DOWN key/→ R key: Enlarges a region.  
↑ UP key/← L key: Reduces a region.  
(Holding the keys down moves the region at high speed.)

### Combining multiple shapes

Depending on the measurement item, up to five shapes can be combined to set a measurement region. Combining various shapes in this way allows you to draw complex shape regions or exclude unwanted parts from the measurement region.

Item	Description
OR	When drawing a complex shape, register a combination of shapes as a single region.
NOT	This item is used for excluding part of a region.

Example:

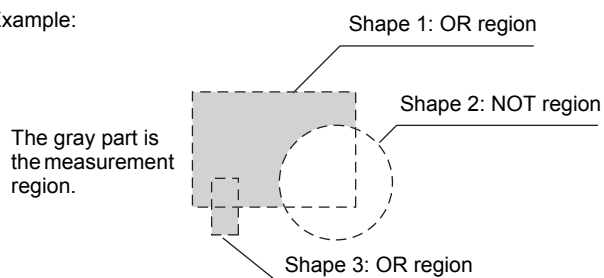







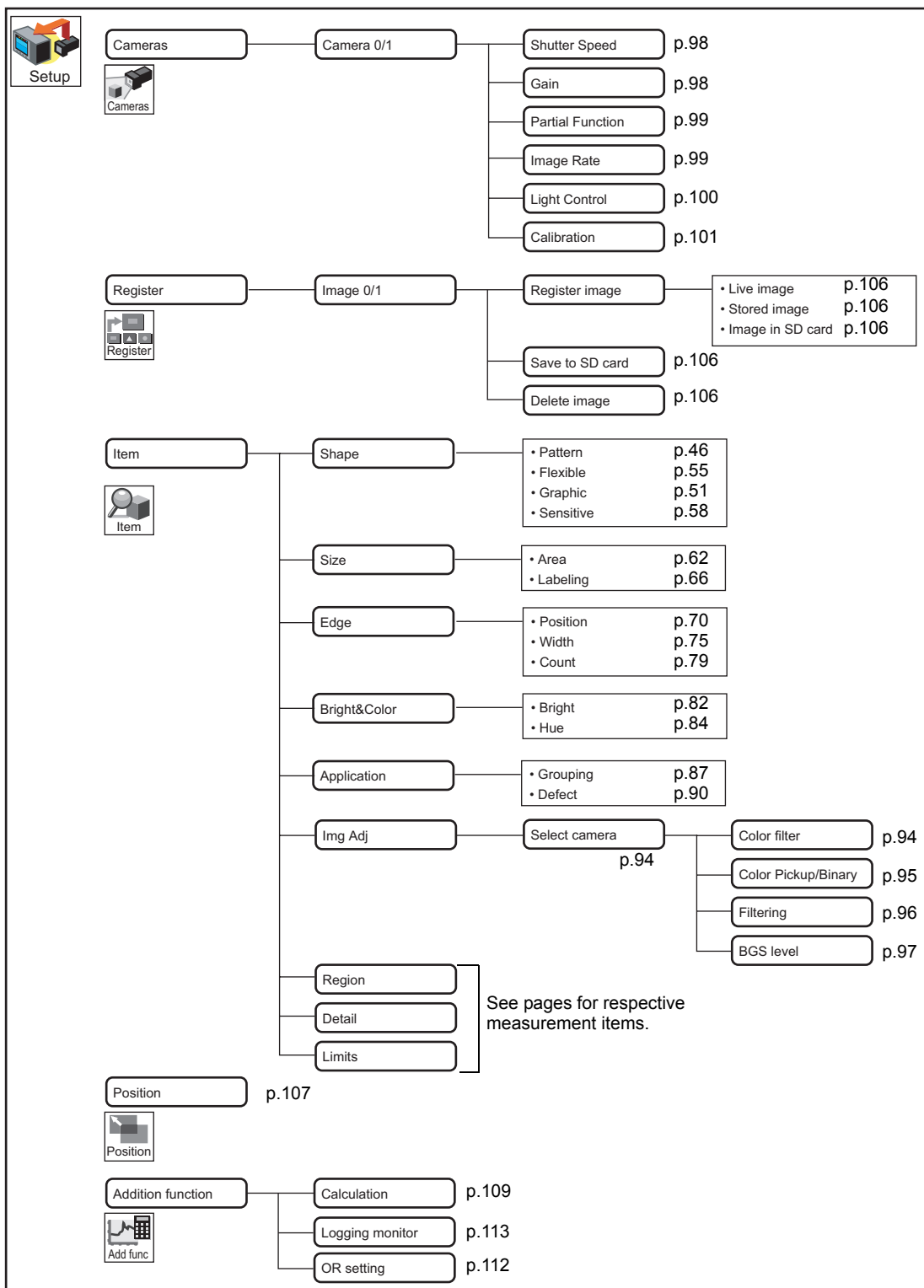









The shapes that can be selected differ according to the measurement item. Only selectable shapes are displayed.

Shape	How to draw this shape
Box	<p>The entire shape moves. The bottom right coordinates move.</p>
Circle	<p>The entire shape moves. The diameter is changed.</p>
Ellipse	<p>The entire shape moves. The bottom right coordinates move.</p>
Polygon	<p>Specification of 1st point      Specification of 2nd point      Specification of 3rd point onwards      Applying the shape      The shape moves (only when it is corrected).</p>
Circum	<p>The entire shape moves.      The diameter is changed.      The width is changed.</p>
Arc	<p>The entire shape moves.      The end point moves.      The center moves.      The width is changed.</p>
Box (diagonal development)	<p>The entire shape moves.      The end point moves.      The width is changed.      The shape moves.      The new size is applied.</p>

# Menu List



 System	Camera	Camera 0/1	White balance	p.128
	 Camera		Strobe delay time	p.128
			Strobe polarity	p.128
			Strobe width	p.128
			Trigger delay time	p.128
	Comm	RS-232C/422		p.128
	 Comm	Normal		p.129
		Parallel		p.129
		OR output		p.130
		ENABLE range		p.130
		Ethernet		p.131
	Output	Data output		p.132
	 Output	Judgement output		p.132
		Date format (Serial)		p.133
		Date format (SD Card)		p.133
		Total jg. output		p.132
	Display	ECO mode		p.134
	 Display			
	Operation	Display capture		p.135
	 Operation	Save at switch Bank Group		p.136
		Password		p.136
		RUN mode key lock		p.136
	Measure	Image storage		p.137
	 Measure	Trig in measure		p.138
	Startup	Startup Bank Group		p.138
	 Startup	Startup Bank		p.138
	Language			p.138
	 Language			
	Date			p.139
	 Date			
	Initialize			p.143
	 Init.			

 Tool	Backup	Image data	p.140
	 Backup	Bank group data	p.140
		Bank data	p.140
		System data	p.140
		SD card	p.141
 SD card			
Profile	p.141		
 Profile			
I/O monitor	RS-232C/422	p.142	
 I/O mon.	Parallel	p.143	
	Sys info	p.35	
 Sys Info			

 Bank	Bank Group	p.126
	Bank	p.126

 Save	p.36
---	------



# INDEX

## Symbols

"Measuring" indicator 17

### A

Additional Functions 109  
 ADJ Mode 31, 42, 119  
 Adjusting Measurement  
 Conditions 122  
 Area 62  
 AUTO Setting in Individual  
 Adjustment Screens 169  
 AUTO Setting of Measurement  
 Items 168  
 Automatic setting 41

### B

Bank 127  
 Bank Group 127  
 Bank Settings 126  
 BGS level 97  
 Bright 82  
 Brightness Value 206

### C

Calibration 101  
 Camera  
   Connecting 29  
   Extension cable 15  
   External Dimensions 173  
   Installing 19  
   Part Names and Functions 16  
   Specifications 170  
 Checking Density Distribution 141  
 Checking Measurement Status 119  
 Checking/Adjusting the  
 Measurement 119  
 Circuit diagram 150, 151  
 Color Filter 202  
 Color images processing 201  
 Color Pickup 204  
 Connecting Devices 28  
 Connecting the camera 29  
 Connecting the power supply 28  
 Console connector 18  
 Control keys 17  
 Controller  
   External Dimensions 177  
   Installing 25  
   Part Names and Functions 17

Specifications 176  
 Coordinates mode 74  
 Count 79

### D

Data 109  
 Defect 90  
 Definitions of Laser  
 Classification 191  
 Displaying Measurement  
 Information 116

### E

ECO Display 134  
 Edge Inspection 70  
 Error indicator 17  
 Exhaust Unit 30

### F

Ferrite Core 28  
 Flexible Search 55

### G

Gain Setting 98  
 Graphic Search 51  
 Grouping 87

### H

How Items Are Displayed on the  
 Logging Monitor 118  
 HUE 84  
 Hue, Saturation and Brightness  
 Value 206

### I

Image Adjustment 94  
 Image deletion 137  
 Image Rate 99  
 Individual judgment result 154  
 Initialization 35  
 Input Methods 192  
 Inspection by Individual  
 Application 87  
 Item No. 110

### J

Judge 109  
 Judgment indicator 17

**K**

---

Key Lock	136
----------	-----

**L**

---

Labeling	66
Light Control	100
Loading Data	140
Logging monitor	113, 116, 118, 119

**M**

---

Measurement items	
Selecting	39
Measurement items and banks	33
Measurement regions	
Setting	40
Measurement values/judgment	109
Menu Buttons	117, 120
MENU Mode	31, 38
Mode switch	17
Monitoring the Measurement	
Status	116

**O**

---

Optical chart	
Camera only	22
Camera with lighting	19
Optional lighting	30
Overall judgment result	154

**P**

---

Panel output dimensions	183
Parallel Connector	
Specifications	146
Parallel port	18
Parameter Setup	193
Partial Function Settings	99
Pattern Search	46
Position	70
Position Correction	107
Power connector	18
Profile	141

**R**

---

Registering Images	106
Revision History	208
RS-232C/422 connector	18
RUN Mode	31, 42, 116

**S**

---

Saturation	206
Saving Data	140
Saving Setup Data	36
Select Camera	94

Sensitive Search	58
Setting Reflection of Individual	
Results	112
Setting regions	41
Setting the Region	194
Shape Inspection	46
Shutter Speed	98
Size Inspection	62
Statistical data	116, 119
Summary of Requirements to	
Manufactures	188
Summary of Requirements to	
User	190
System Configuration	14

**T**

---

Terminal Block Adapter	146
Timing Charts	156
Trigger indicator	17

**U**

---

USB port	17
----------	----

**V**

---

Variables	109
-----------	-----

# How Color Images are Processed

The ZFX-C performs measurement with the processes "Color filter" or "Color Pickup" applied to images captured from the camera.

This section describes how color images are processed.

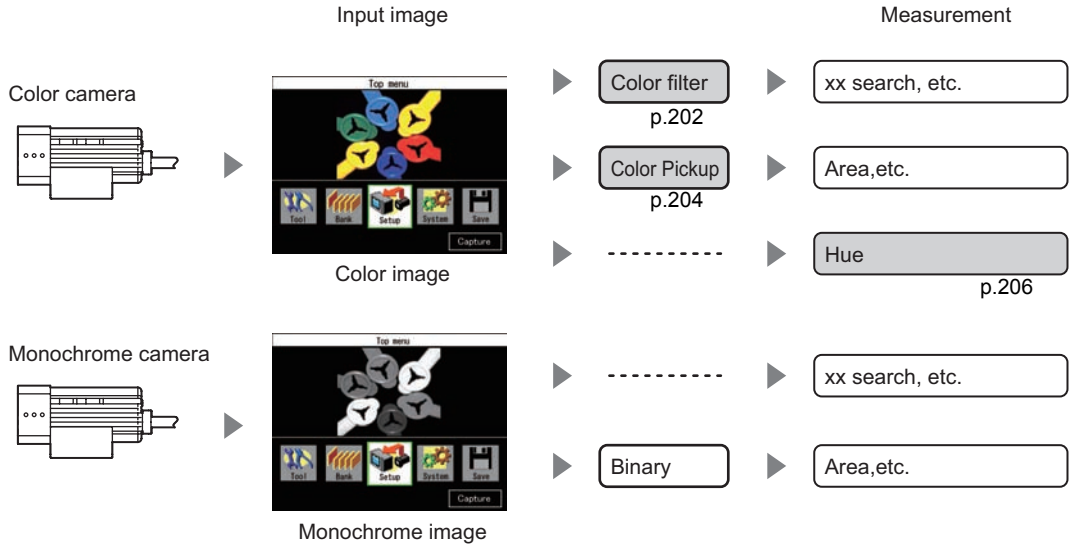

# Color Filter

This function improves the contrast of images. This function can be set only when a color camera is connected to the Controller.

Example:

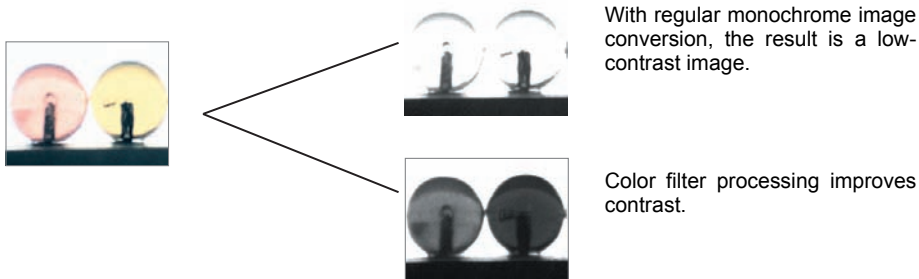

## Setting color filter processing

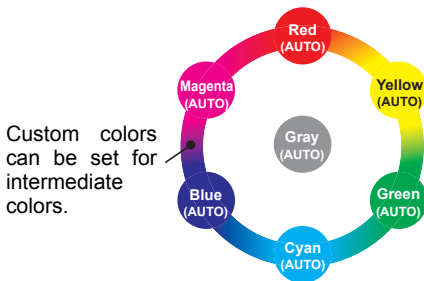

Custom colors can be set for intermediate colors.

There are three ways of setting custom colors:

### AUTO

The optimum filter is automatically selected from seven color filters.

### Select filter

This setting allows you to select from six color filters + gray filter to match the color whose contrast is to be improved.

### Custom filter

This setting allows you to set the color filter to any custom color. You can select the desired color from the color palette.

### Note

For monochrome images, the color of the currently selected filter is displayed as white and complementary colors are displayed as black. "Complementary colors" refers to colors that lie on opposite sides of the white point in a chromaticity diagram.

Example: When the blue filter is selected, blue is displayed as white and yellow is displayed as black.

## AUTO

With measurement items that can use color filters, the optimum color filter is automatically set when the AUTO setting is executed. The color filter for enhancing the contrast between the color having the largest area and the color having the second largest area in the region is selected.

## Select Filter

The color filter can be selected to match the color whose contrast is to be improved. You can choose from Red, Blue, Green, Yellow, Cyan, Magenta, Gray, and Custom as the color filters.

### ► MENU mode - [Setup] - [Item] - [Img Adj] - [Select camera] - [Color filter] - [Select filter]

When "Blue" is selected:



**1** Select the desired color.

**2** Select [Apply].

The color bar is displayed when [Custom] is selected from the color filters. You can set any color from this color bar to custom filters.

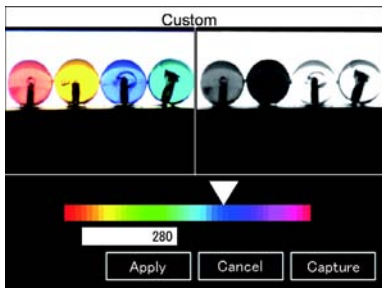

## Fixing the Color Filter

To hold the color filter without changing its settings when the AUTO setting is next executed, change [Auto function] to [OFF].

### ► MENU mode - [Setup] - [Item] - [Img Adj] - [Select camera] - [Color filter] - [Auto function]

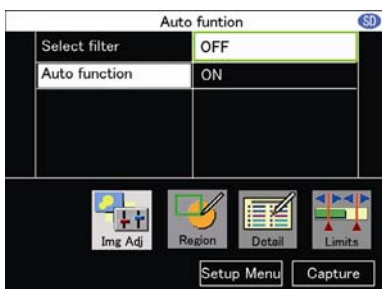

**1** Select [OFF].

# Color Pickup

This function picks up colors to be measured. This function can be set only when a color camera is connected to the Controller.

Up to four measurement target colors can be specified for one measurement item.

► MENU mode - [Setup] - [Item] - [Img Adj] - [Select camera] - [Color Pickup]

Automatically picking up colors

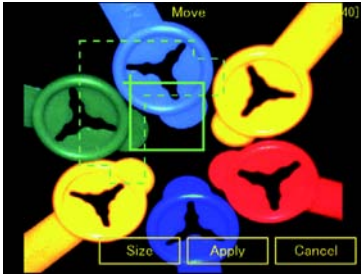

## 1 Select [Region].

Specify the area having the color to be measured.

 For details on how to set the region p.194

## 2 Select [PickUp].

## 3 Select [AUTO].

Candidates for up to four colors are displayed in order of the color having the largest area.

## 4 Check whether or not the color to be measured is picked up.

Select the icon of a candidate color. Only an image of the corresponding color is displayed.

## 5 If there are colors not to be used as the measurement target, select [Enable/Disable]-[Disable].

Enable: The picked up color is used as the measurement target.

Disable: The picked up color is not used as the measurement target.

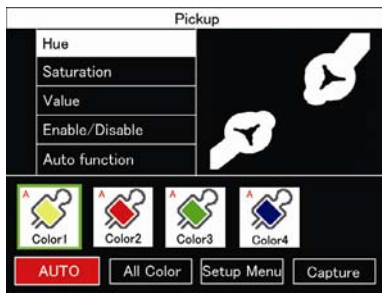

If the appropriate image is not obtained by automatic color pick up, fine-adjust three parameters hue, saturation and brightness. The image can be adjusted while comparing the picked up color image and original image.

**6** Select [Hue/Saturation/Value].

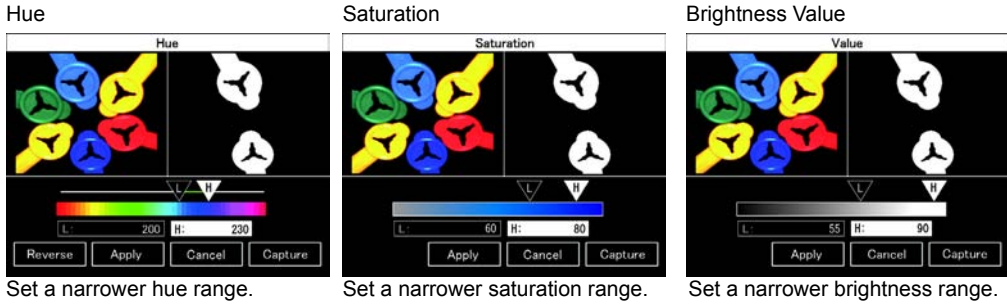

Hue, Saturation and Brightness Value p.206

**7** Select [Apply].

**8** Select [Auto function]-[OFF].

The picked up color is fixed. The icons of fixed colors are not cleared and are held even if the AUTO button is selected again.

# Hue, Saturation and Brightness Value

The parameters hue, saturation and brightness value are used in the measurement values in color inspection.

Parameter	Description
Hue	The name of a color, such as red, yellow or blue, that is perceived subjectively. Hue is expressed by a chromaticity diagram.
Saturation	The degree to which color is mixed with white. When a color has little saturation, it becomes an achromatic color. The higher saturation becomes, the purer the color becomes in proportion to hue.
Brightness value	The ratio of light intensity in a color.

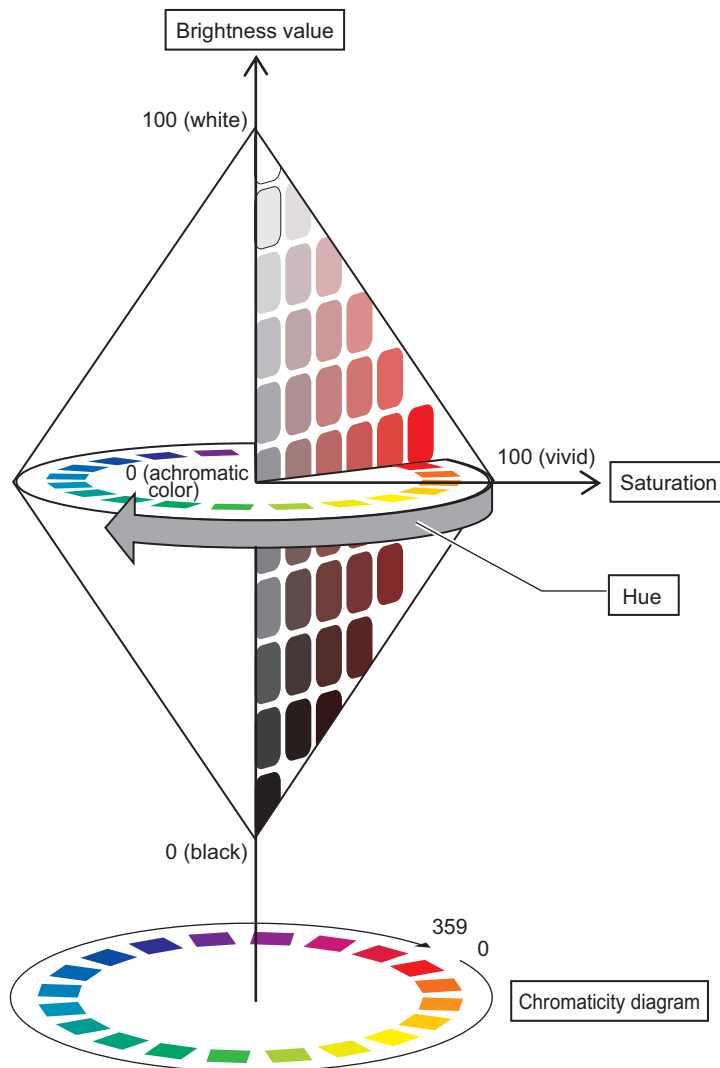



# Version Upgrade Information

The following describes the content of the version upgrade.

Ver1.00 → Ver1.20

Changes	Reference
The "coordinates mode" function has been newly added to the following measurement items. Pattern Search, Graphic Search, Flexible Search, Sensitive Search, Area, Labeling, Position, Width, Grouping, Defect	p.74
Camera images can now be displayed also when the "Variables list," "Data list" and "Judgments list" are displayed in the RUN mode or the ADJ mode.	p.118 p.121
Measurement data can now be prefixed with time information when measurement information is output on the serial interface or to SD card.	p.133
Clearing or holding saved image data in memory can now be selected at bank switching.	p.137

# Revision History

A manual revision code appears as a suffix to the catalog number at the bottom of the front and back covers of this manual.

Cat. No. Z264-E1-02

↑  
Revision code

Revision code	Date	Revised contents
01	April 2007	Original production
02	August 2007	New details as explained in "Version Upgrade Information" added (Ver1.20)